

ADEMCO LYNXR-ENSIA Security Systems

Installation and Setup Guide



RECOMMENDATIONS FOR PROPER PROTECTION

The Following Recommendations for the Location of Fire and Burglary Detection Devices Help Provide Proper Coverage for the Protected Premises.

Recommendations for Smoke and Heat Detectors

With regard to the number and placement of smoke/heat detectors, we subscribe to the recommendations contained in the National Fire Protection Association's (NFPA) Standard #72 noted below.

- Early warning fire detection is best achieved by the installation of fire detection equipment in all rooms and areas of the household as follows: For minimum protection a smoke detector should be installed outside of each separate sleeping area, and on each additional floor of a multi-floor family living unit, including basements. The installation of smoke detectors in kitchens, attics (finished or unfinished), or in garages is not normally recommended.
- For additional protection the NFPA recommends that you install heat or smoke detectors in the living room, dining room, bedroom(s), kitchen, hallway(s), attic, furnace room, utility and storage rooms, basements and attached garages.

In addition, we recommend the following:

- Install a smoke detector inside every bedroom where a smoker sleeps.
- Install a smoke detector inside every bedroom where someone sleeps with the door partly or completely closed. Smoke could be blocked by the closed door. Also, an alarm in the hallway outside may not wake up the sleeper if the door is closed.
- Install a smoke detector inside bedrooms where electrical appliances (such as portable heaters, air conditioners or humidifiers) are used.
- Install a smoke detector at both ends of a hallway if the hallway is more than 40 feet (12 meters) long.
- Install smoke detectors in any room where an alarm control is located, or in any room where alarm control connections to an AC source or phone lines are made. If detectors are not so located, a fire within the room could prevent the control from reporting a fire or an intrusion.

THIS CONTROL COMPLIES WITH NFPA REQUIREMENTS FOR TEMPORAL PULSE SOUNDING OF FIRE NOTIFICATION APPLIANCES.

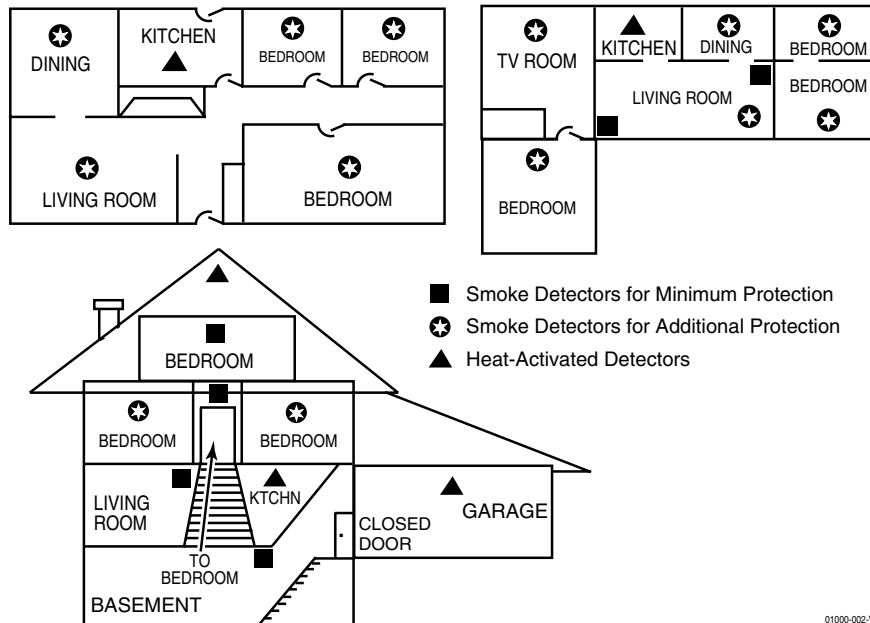

01000-002-V0

Recommendations For Proper Intrusion Protection

- For proper intrusion coverage, sensors should be located at every possible point of entry to a home or premises. This would include any skylights that may be present, and the upper windows in a multi-level building.
- In addition, we recommend that radio backup be used in a security system. This will ensure that alarm signals can be sent to the alarm monitoring station in the event that the telephone lines are out of order (alarm signals are normally sent over the phone lines, if connected to an alarm monitoring station).

Table of Contents

SYSTEM FEATURES	4
MOUNTING THE CONTROL.....	5
WIRING CONNECTIONS.....	6
AC POWER AND BACKUP BATTERY.....	9
INSTALLING WIRELESS ZONES.....	11
MECHANICS OF PROGRAMMING	14
ZONE RESPONSE TYPE DEFINITIONS	15
DATA FIELD DESCRIPTIONS	17
*56 ENHANCED ZONE PROGRAMMING MODE	28
*80 DEVICE PROGRAMMING MENU MODE	32
*81 ZONE LIST MENU MODE.....	35
*83 ENHANCED SEQUENTIAL MODE	36
*84 ASSIGN ZONE VOICE DESCRIPTORS	39
*85 RECORD CUSTOM VOICE DESCRIPTORS.....	41
VOICE PROMPT PROGRAMMING	42
REMOTE PROGRAMMING/CONTROL (DOWNLOADING)	46
SYSTEM OPERATION.....	48
TESTING THE SYSTEM.....	54
SYSTEM COMMUNICATION	55
TROUBLESHOOTING GUIDE	57
CONTACTING TECHNICAL SUPPORT.....	59
REGULATORY AGENCY STATEMENTS	60
SPECIFICATIONS.....	61
LYNXR-ENSIA PROGRAMMING DEFAULT TABLES.....	62
INDEX.....	65
UL NOTICES.....	69
SIA QUICK REFERENCE GUIDE.....	69
LIMITATIONS OF THIS SYSTEM STATEMENT.....	70
SUMMARY OF CONNECTIONS DIAGRAM	71
WARRANTY	Rear Cover

System Features

UL

LYNXR-ENSIA is not intended for UL985 Household Fire applications unless a 24-hour backup battery (P/N LYNXRCHKIT-HC) is installed.

Powerline Carrier Devices are not UL Listed for fire or burglary functions and are intended for home automation.

The LYNXR-ENSIA controls are self-contained, rechargeable wireless control/communicators that feature easy installation and usage. A built-in speaker provides voice annunciation of system status along with voice descriptors of each zone (if programmed). The following illustration highlights the main features of this system.

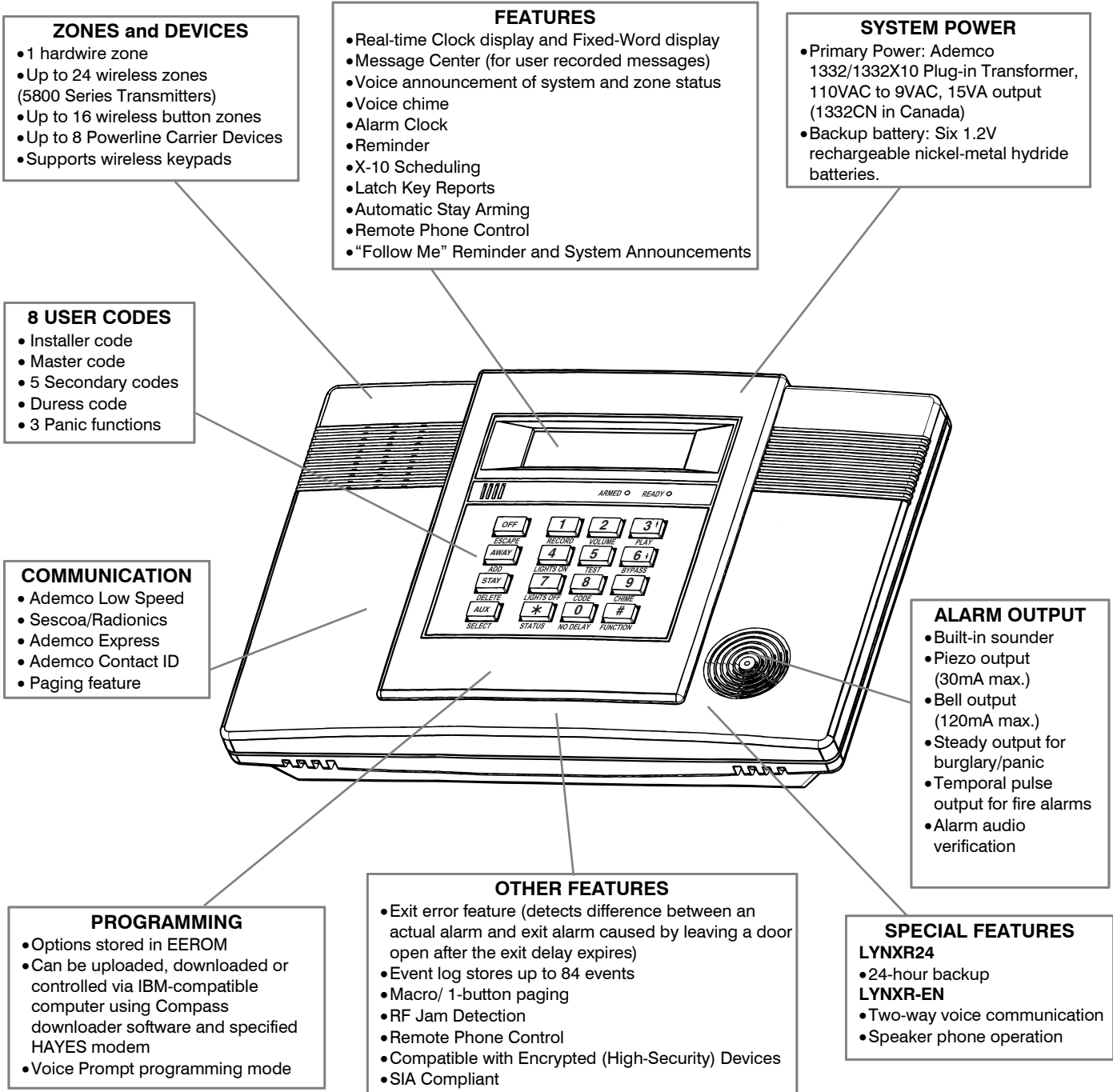

Mounting the Control

Wall Mounting

The illustration below shows the front assembly separated from the back plate.



DO NOT disconnect the ribbon cable from the terminal strip board. Disconnect the cable only from the front assembly board.

1. Separate the front assembly from the back plate by pressing on the two locking tabs at the top of the unit.
2. Carefully disconnect the ribbon cable from the front assembly, **leaving the ribbon cable connected to the terminal block PC board.** The back plate contains the terminal block for making wiring connections.
3. Mount the back plate to a sturdy wall, feeding the field wiring through the appropriate openings in the back plate.
4. After wiring connections are made, carefully reconnect the ribbon cable to the front assembly PC board connector (properly aligning the red wire).
5. Before closing the assembly, verify which LYNXR model is being installed by checking the model number printed on the PC Boards. (Example: SALYNXR-EN indicates the unit being installed is a LYNXR-EN.)
6. Snap the front assembly to the back plate so it is secured by the locking tabs.

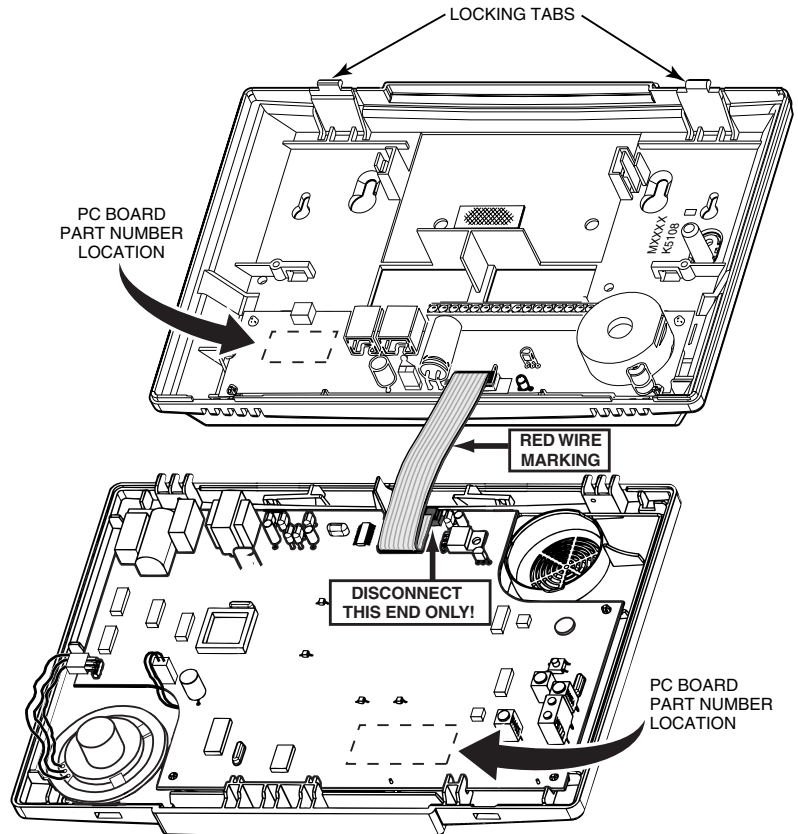

0600-003-V0

Desktop Mounting

If desired, an optional mounting base (model LYNX-DM, purchased separately) allows the LYNXR-ENSIA controls to be used on a desktop.

1. Slide the control panel onto the mounting base locking tabs.
2. Bring all wiring through the bottom of the mounting base, using one of the three wire entry locations, before making connections to the control panel.
3. Use tie-wraps to secure the wiring to the built-in wire loops as needed. Use the two supplied screws to secure the control panel to the mounting base.



01009-004-V1

Wiring Connections

Wiring Overview

The following summarizes the connections required. Refer to the Wiring Connections paragraph and the Summary of Connections diagram on the inside back cover when making connections.

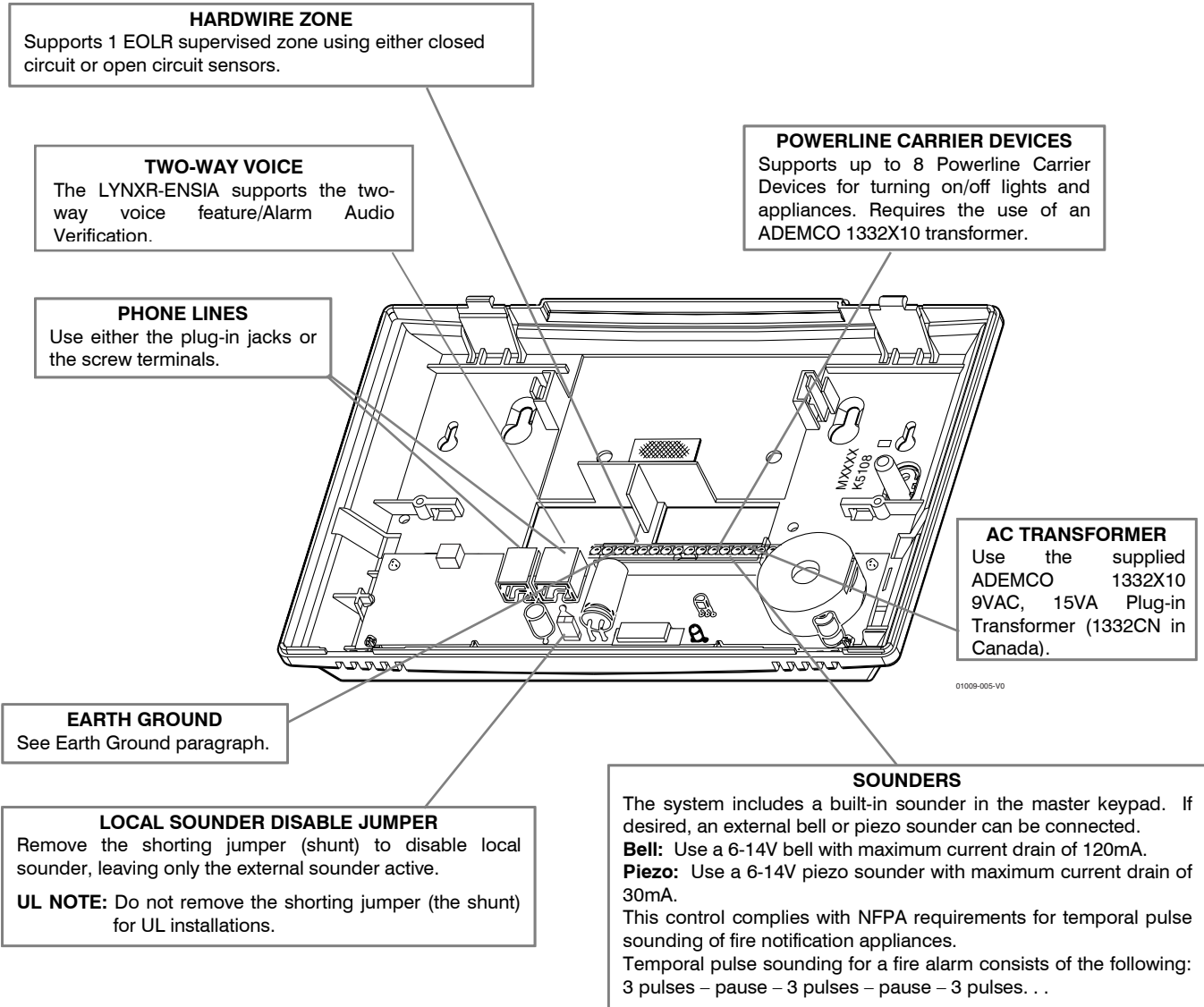

Wiring Connections

1. **Make Earth Ground Connection** - The designated earth ground terminal (1) must be terminated in a good earth ground for the lightning transient protective devices in this product to be effective. The following are examples of good earth grounds available at most installations:
 - Metal Cold Water Pipe - Secure a non-corrosive metal strap (copper is recommended) to the pipe that is electrically connected and secured to which the ground lead.
 - AC Power Outlet Ground - Available from 3-prong, 120VAC power outlets only. To test the integrity of the ground terminal, use a three-wire circuit tester with neon lamp indicators, such as the UL Listed Ideal Model 61-035, or equivalent, available at most electrical supply stores.
- a. Connect terminal 1 to a good earth ground.

Wiring Connections

Wiring Connections

2. **Make Phone Line Connections** - For local or full line seizure proceed to the appropriate steps below.

Local Seizure

- a. Connect the incoming phone line to either the 8-position jack or terminals 2 (TIP) and 3 (RING) on the Lynx.
- b. Connect the handset phone lines to either the RJ11 jack or terminals 4 (TIP) and 5 (RING).

Full Line Seizure: The control must be placed in **series** with the incoming phone line. Plugging the Direct Connect Cord directly into the RJ31X jack, allows the control to seize the phone line when an alarm occurs and normal phone line usage by the premises phones if the plug needs to be removed.

- a. Cut the incoming RING and TIP phone lines (typically red and green, respectively) and connect them to RJ31X terminals 4 (red) and 5 (green).
- b. Connect the premises end of the cut RING and TIP wires to RJ31X terminals 1 (grey) and 8 (brown) respectively.
- c. Wire the flying leads of a Direct Connect Cord to the control's phone terminals as shown in the diagram or plug into the 8-position jack.
- d. Plug the Direct Connect Cord into the RJ31X jack.

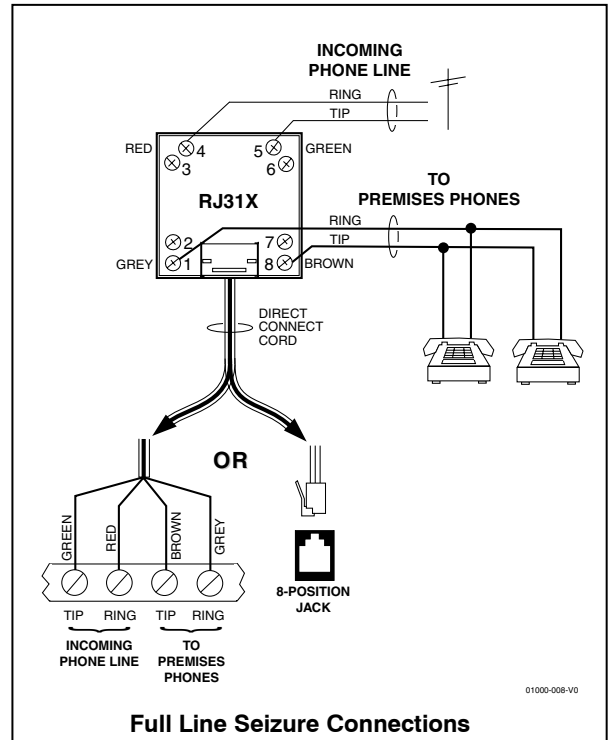

HARDWIRED ZONE: If the EOLR is not at the end of the loop, the zone will not be properly supervised, and the system may not respond to an open circuit on the zone.

3. **Make Hardwired Zone Connections** - Zone 1 is an EOLR supervised zone that supports both open circuit and closed circuit devices and has a response time of 350msec. Maximum zone resistance: 300 ohms, plus EOLR

Note: The hardwire zone cannot be used as a fire zone.

- a. Connect sensors/contacts to the hardwired zone terminals 6 (+) and 7 (-). Refer to the Summary of Connections diagram.
- b. Connect closed circuit devices in series in the high (+) side of the loop. The EOL resistor must be connected in series with the devices, following the *last device*.
- c. Connect open circuit devices in parallel across the loop. The 2000-ohm EOLR must be connected across the loop *at the last device*.

4. **Make External Sounder Connections** - The control panel supports either a 6-14VDC piezo sounder (30mA max.) or 6-14VDC bell (120mA max.; e.g. ADEMCO WAVE2EX).

- a. Connect a piezo sounder to terminals 10 (+) and 11 (-); OR a bell to terminals 11 (-) and 12 (+).



LOCAL SOUNDER DISABLE: The Master Keypad's built-in piezo sounder can be disabled by removing the shorting jumper (shunt) on the terminal board. If disabled, however, no sounding will occur upon AC loss, since the external sounder does not operate when AC power is lost.



Do not remove shorting jumper (the shunt) for UL installations.

5. **Disable Local Sounder Option** - If required the Master Keypad's built-in piezo sounder can be disabled.

- a. Remove the shorting jumper (shunt) on the terminal board.

6. **Make Powerline Carrier Device Connections** - The control panel supports up to 8 Powerline Carrier Devices. If using these devices, they must be connected to the ADEMCO 1332X10 transformer, as shown in the SUMMARY OF CONNECTIONS diagram.

- a. Connect the com/data/sync/ lines from the ADEMCO 1332X10 transformer to terminals 9, 13, and 14, respectively.

Note: If not using the supplied Ademco connection cable, you may need to reverse the black and yellow wire connections. Refer to the **:80 Device Programming Menu Mode* section for details on programming Powerline Carrier Devices.

Wiring Connections

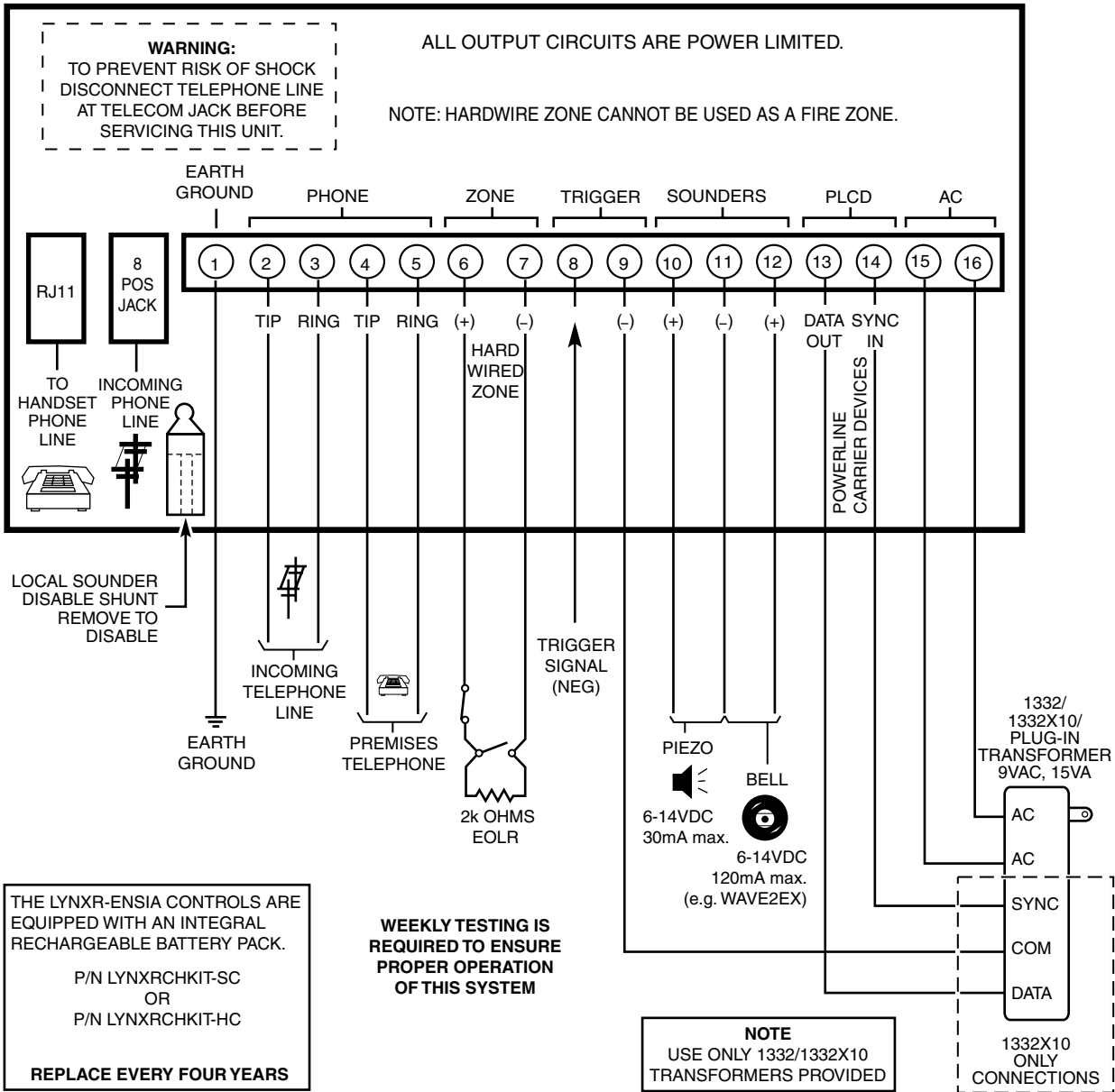

06000-009-V0

AC Power and Backup Battery

The system is powered by a 9VAC, 15VA Plug-in Transformer, ADEMCO 1332/1332X10. Refer to the wiring table below for wire gauge and length.



Use only the provided ADEMCO 1332/1332X10 Transformer

Distance from Transformer to Control	Wire Gauge
Up to 75 feet	#20
75 to 150 feet	#18
150 to 300 feet	#16



Wiring to the AC Transformer must not exceed 300 feet using 16-gauge wire. The voltage reading between terminals 15 and 16 of the control must not fall below 9.00VAC.

Do not plug the transformer into the AC outlet until after all wiring connections have been made.

Backup battery. In the event of an AC power loss, the system is supported by a long life backup battery that is supervised for connection and for low voltage conditions. If the battery is missing, or a low battery condition is detected, a “low battery” message is displayed and a report is sent to the central station. In addition, the system will beep once every 45 seconds to audibly indicate a low battery condition (press any key to stop the beeping).

AC Power and Rechargeable Backup Battery

Connecting AC Power and backup battery

1. Connect wires from the 1332/1332X10 AC Transformer to terminals 15 and 16 as shown in the wiring diagram.
2. Remove battery retainer.
3. Peel the backing from tape on the back plate.
4. Insert battery pack into back plate.
5. Install battery retainer.
6. Connect battery connector to receptacle on terminal block PC board.
7. After all wiring connections have been made, snap the front assembly to the back plate and plug the transformer into a 24-hour, 110VAC unswitched outlet.

Note: Rechargeable batteries may take up to 48-hours to fully charge. The “LOW BAT” message should clear within four hours or by entering Test Mode.

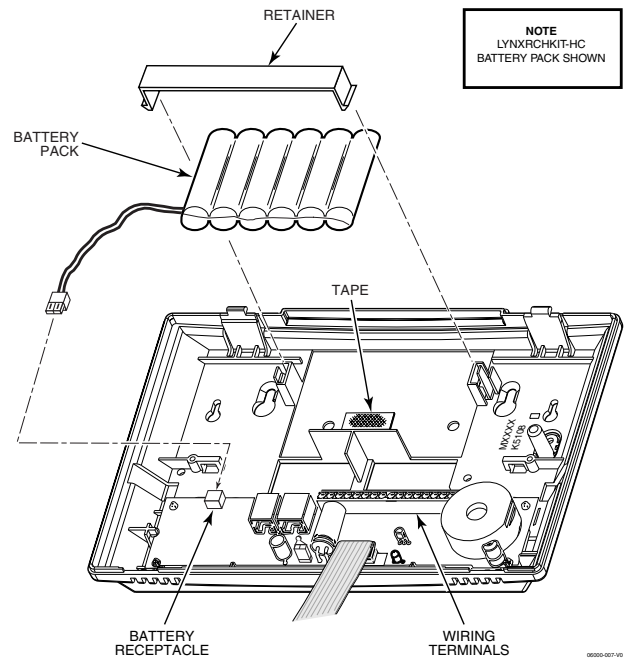

Ensure the cover is snapped closed prior to applying AC power.

AC Power and Backup Battery

AC Power and Rechargeable Backup Battery

The LYNXR-ENSIA is equipped with an integral, replaceable, rechargeable battery pack composed of six (6) rechargeable 1.2-volt nickel-metal hydride batteries. Select the appropriate battery pack, based on the installation's requirement, and install the battery pack.

Model/Part Number	Battery StandbyTime	Low Battery Notification
LYNXRCHKIT-SC	4-hours (minimum)	Approximately 1-hour before battery depletion
LYNXRCHKIT-HC	24-hours (minimum)	At least 1-hour before battery depletion

Replacing the Rechargeable Battery

1. When battery replacement is required, unplug the transformer from the wall outlet, and open the control panel cover.
2. Remove the battery retainer and disconnect the battery pack connector from the receptacle on the terminal block PC board.
3. Remove the battery pack from the back plate.
4. If required, replace the tape that secures the battery pack.
5. Install a replacement battery pack (P/N LYNXRCHKIT-SC or LYNXRCHKIT-HC) into the back plate.
6. Install the battery retainer.
7. Connect the battery connector to the receptacle on the terminal block PC board.
8. After the wiring connection has been made, snap the front assembly to the back plate.
9. Plug the transformer into a 24-hour, 110VAC unswitched outlet.
10. Rechargeable batteries may take up to 48-hours to fully charge. The "LOW BAT" message should clear within four hours or by entering Test Mode.

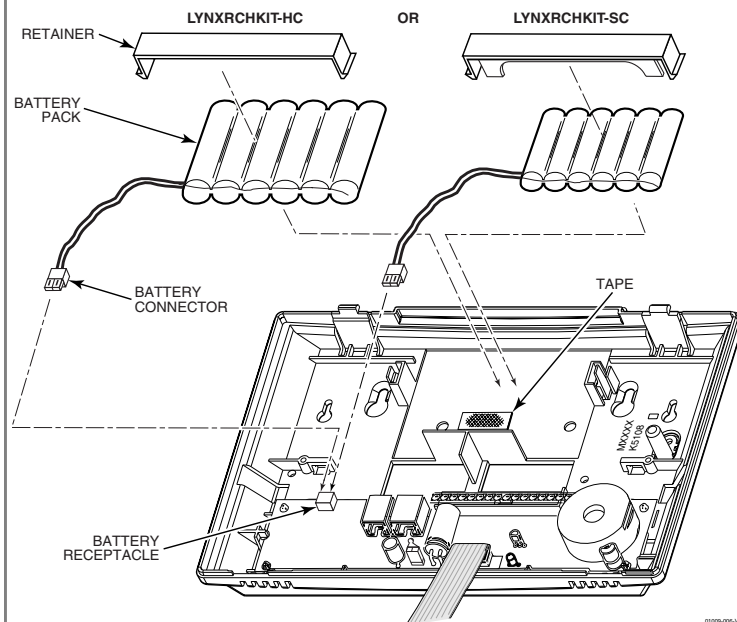

Ensure the control panel assembly is snapped closed prior to applying AC power.

Installing Wireless Zones

General Information

Zones: The control supports up to 24 wireless zones using 5800 Series transmitters, and up to 16 wireless buttons.

Range: The built-in RF receiver can detect signals from wireless transmitters within a nominal range of 200 feet.

Transmitters: 5800 Series transmitters have built-in serial numbers that must be entered into the system using the *56 or *83 interactive mode, or input to the control via the downloader. 5800 Series transmitters (except the 5800RL, which is described separately) do not have DIP switches. Each transmitter's zone number is programmed into the system in *56 mode. Some transmitters, such as the 5816 and 5817, can support more than one "zone" (referred to as loops or inputs). On the 5816, for example, the wire connection terminal block is loop 1, the reed contact is loop 2. Each loop must be assigned a different zone number.

The 5816 and 5817 Transmitters do not have EOL supervision of their loop wiring. Therefore, for UL Household Burglary installations, the loop wiring may not exceed 3 feet.

UL

The 5800RL, 5802MN, 5802MN2, 5804, 5804BD, 5804BDV, 5804E, 5814, 5816TEMP, 5819, 5819S(WHS & BRS), 5828/5828V and 5850(GBD) transmitters are not intended for any UL installations.

For button transmitters (RF "keys") such as the 5804 and 5801, you must assign a unique zone number to each individual button used on the transmitter. Each button on the transmitter also has a pre-designated loop or input number, which is automatically displayed.

Note: The 5806 smoke detector must be used in SIA applications.

House Identification

If you are using a 5804BD/5804BDV Wireless Keypad with the system, you must program a House ID Code (01–31) in field *24 to establish proper communication, and the keypad must be set to the same ID. House ID 00 disables all wireless keypads. An RF House ID is not necessary for other 5800 Series transmitters; the entry should be left at "00" (default) in those cases.

Transmitter Supervision

Except for some transmitters/keypads that may be carried off-premises (5804, 5804BD, 5804BDV and 5804E), each transmitter is supervised by a check-in signal that is sent to the receiver at 70–90 minute intervals. If at least one check-in is not received from each supervised transmitter within a 12-hour period, the "missing" transmitter number(s) and "FAULT" will be displayed. The supervision for a particular transmitter in the system that may also be carried off the premises (5801, 5802MN) may be turned off by entering it as a "UR" (unsupervised RF) type, as described in the *56 *Enhanced Zone Programming Mode* section.

5800 Series transmitters have built-in tamper protection and will announce as a fault condition if covers are removed.

Transmitter Input Types

Each of the following transmitters has one or more unique factory-assigned input (loop) ID codes. Each of the inputs requires a programming zone (e.g., a 5804's four inputs require four button zones).

Transmitters can be entered as one of the following types (see transmitter's instructions for appropriate input type):

Type	Description
"RF" (Supervised RF)	Sends periodic check-in signals, as well as fault, restore, and low battery signals. The transmitter must remain within the receiver's range.
"UR" (Unsupervised RF)	Sends all the signals that the "RF" type does, but the control does not supervise the check-in signals. The transmitter may therefore be carried off-premises.
"BR" (Unsupervised Button RF)	These only send fault signals. They do not send low battery signals until they are activated. The transmitter may be carried off-premises.

Installing Wireless Zones

Transmitter Battery Life

- Batteries in the wireless transmitters may last from 4–7 years, depending on the environment, usage, and the specific wireless device being used. Factors such as humidity, high or low temperatures, as well as large swings in temperature may all reduce the actual battery life in a given installation. The wireless system can identify a true low battery situation, thus allowing the dealer or user of the system time to arrange a change of battery and maintain protection for that point within the system.
- Button-type transmitters should be periodically tested for battery life. The 5801, 5802MN, 5802MN2, 5804, 5804BD, 5804BDV, and 5804E button transmitters have replaceable batteries.

Using the Transmitter Sniffer Mode

Use this mode after all transmitters have been entered to check that all transmitters have been properly programmed.

1. Enter **Installer code (4112) + [#] + 3**.

Note: If the communicator is in the process of sending a report to the central station, the system will not go into the Sniffer mode. If so, wait a few minutes and try again.

2. The keypad will display all zone numbers, which have a non-zero Zone Type (even if serial numbers were not learned yet). Fault each transmitter in turn, causing each one to send a signal. As the system receives a signal from each of the transmitters, the zone number of that transmitter will **disappear** from the display. The transmitters may be checked upon installation, or in an installed system.
3. When all transmitters have been checked, exit Sniffer mode. Enter **Installer Code (4112) + OFF**.

- Notes:**
- (1) Sniffer mode does not automatically expire. You must manually exit (Installer Code + OFF) Sniffer mode to return to normal operation.
 - (2) All BR-type units must physically be activated to clear the display, since they do not automatically send check-in signals.
 - (3) When one button of a transmitter (RF, UR, or BR) is activated, all zones assigned to other buttons on that transmitter are cleared. This also applies to 5816 and 5817 transmitters that have multiple loops (zones).
 - (4) Any transmitter that is not “entered” will not turn off its zone number.
 - (5) Fire verification is disabled when the system is in sniffer mode

Go/No Go Test Mode



5804E encrypted (High-Security) devices must be activated while the system is in Go/No Go Test Mode. Refer to the transmitter’s installation instructions for complete details. The system will confirm enrollment of the encrypted device by beeping two times.

The Go/No Go tests will verify adequate RF signal strength from the proposed transmitter location, and allow you to reorient or relocate transmitters if necessary, before mounting the transmitters permanently. This mode is similar to the transmitter Test mode, except that the wireless receiver gain is reduced. This will enable you to make sure that the RF signal from each transmitter is received with sufficient signal amplitude when the system is in the normal operating mode.

1. Enter **Installer Code (4112) + [#] + 8**.
2. Once you have placed transmitters in their desired locations and the approximate length of wire to be run to sensors is connected to the transmitter's screw terminals (if used), fault each transmitter.



Conducting this test with your hand wrapped around the transmitter will cause inaccurate results. On button type transmitters that have been programmed to set ARM AWAY, ARM STAY, or DISARM, pressing a button will take the system out of the Go/No Go Test mode and cause the programmed action to occur.

- Note:** On button type transmitters that have been programmed to set ARM AWAY, ARM STAY, or DISARM, pressing a button will take the system out of the Go/No Go Test mode and cause the programmed action to occur.
- a. The keypad will beep three times indicating signal reception and will display the appropriate zone number.
 - b. If the keypad does not beep, reorient or move the transmitter to another location. Usually a few inches in either direction is all that is required.

Installing Wireless Zones

- If each transmitter produces the proper keypad response when it is faulted, you can then permanently mount each of the transmitters according to the instructions provided with them.
- Exit the Go/No Go Test mode by entering: **Installer Code (4112) + OFF**.

5800 Series Transmitter Loop Numbers (Refer to this information when programming transmitters)

The following illustration shows the compatible transmitters, their associated input types and loop designations.

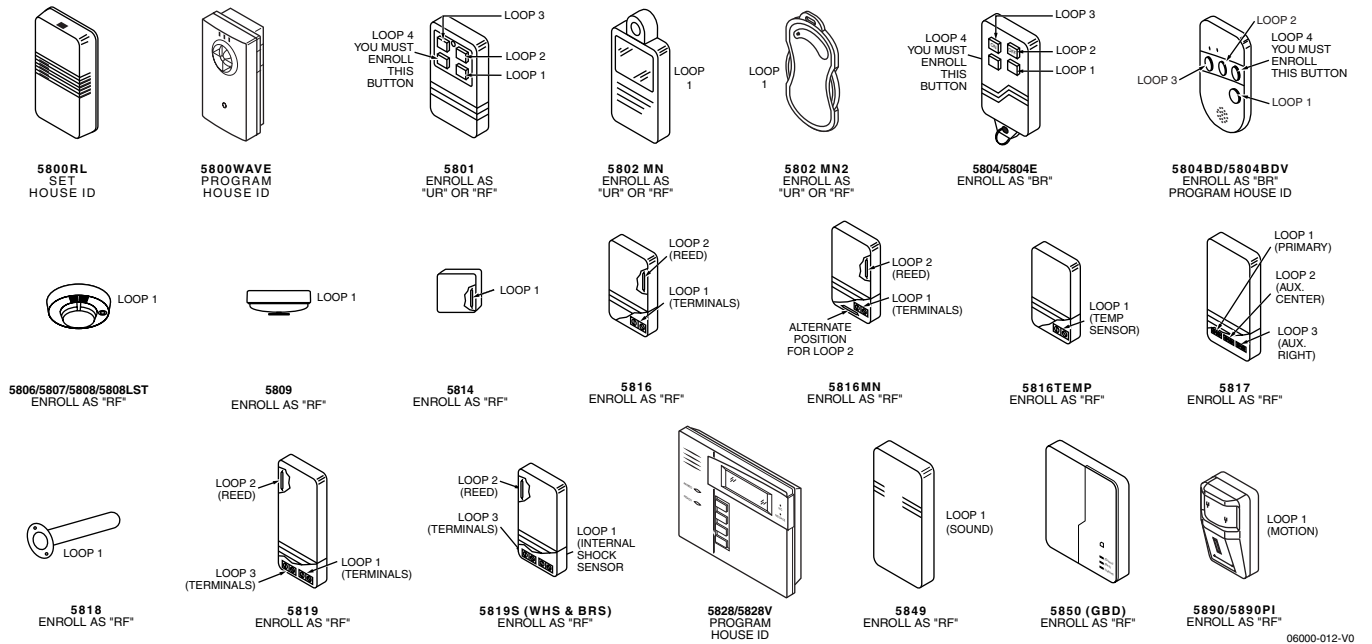

- Notes:**
- Loop 4 must be enrolled on the 5801, 5804, 5804BD, 5804BDV and 5804E transmitters, whether or not the loop is used.
 - 5804E encrypted (High-Security) devices must be activated while the system is in Go/No Go Test Mode. Refer to the transmitter's installation instructions for complete details. The system will confirm enrollment of the encrypted device by beeping two times.
 - The 5806 smoke detector must be used in SIA applications.



The 5800RL, 5802MN, 5802MN2, 5804, 5804BD, 5804BDV, 5804E, 5814, 5816TEMP, 5819, 5819S(WHS & BRS), 5828/5828V and 5850(GBD) wireless transmitters are not intended for any UL installations.

Setting DIP Switches on the 5800RL Transmitter

Set the 5800RL Transmitters to the programmed House ID, by using the DIP switches.

(OFF position is indicated by ---)

Note: The 5800RL cannot be used in conjunction with the Auto Arm (scheduled arming) feature.

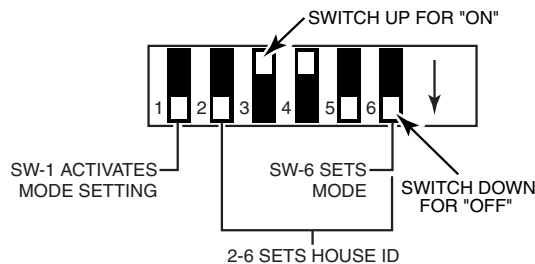

SHOWN SET FOR HOUSE ID# 12

01000-014-V1

5800RL DIP SWITCH TABLE

House ID	DIP SWITCH POSITIONS					House ID	DIP SWITCH POSITIONS				
	2	3	4	5	6		2	3	4	5	6
0	---	---	---	---	---	16	ON	---	---	---	---
1	---	---	---	---	ON	17	ON	---	---	---	ON
2	---	---	---	ON	---	18	ON	---	---	ON	---
3	---	---	---	ON	ON	19	ON	---	---	ON	ON
4	---	---	ON	---	---	20	ON	---	ON	---	---
5	---	---	ON	---	ON	21	ON	---	ON	---	ON
6	---	---	ON	ON	---	22	ON	---	ON	ON	---
7	---	---	ON	ON	ON	23	ON	---	ON	ON	ON
8	---	ON	---	---	---	24	ON	ON	---	---	---
9	---	ON	---	---	ON	25	ON	ON	---	---	ON
10	---	ON	---	ON	---	26	ON	ON	---	ON	---
11	---	ON	---	ON	ON	27	ON	ON	---	ON	ON
12	---	ON	ON	---	---	28	ON	ON	ON	---	---
13	---	ON	ON	---	ON	29	ON	ON	ON	---	ON
14	---	ON	ON	ON	---	30	ON	ON	ON	ON	---
15	---	ON	ON	ON	ON	31	ON	ON	ON	ON	ON

Setting 5800RL DIP Switches

Mechanics of Programming

General Programming Information

Programming options are stored in non-removable, electrically erasable, nonvolatile EEROM memory. The system can be programmed at any time, even at the installer's premises prior to the actual installation. Simply apply power temporarily to the Control and then program the unit as desired. There are two programming modes:

- **Data field programming** (used for setting various system options)
- **Interactive menu mode programming** (used for programming zone information, programming Powerline Carrier Devices, and for entering transmitter serial numbers)

The system can also be programmed remotely, using an IBM Personal Computer, a modem, and Compass Downloader for Windows. See the *Remote Programming/Control (Downloading)* section.

Note: You may find it convenient to adjust the volume setting before entering the Program Mode. This will allow you to clearly hear the feedback announcements or system beeps in the Programming Mode, of the system's built-in speaker. To adjust the volume, press FUNCTION + VOLUME+ [3] or [6]. Upon exiting the Program Mode, the system will reset the volume to the default value (mid level).

Entering Program Mode - Use one of the following methods to enter Programming Mode:

1. Press both the [*] and [#] keys at the same time, **within 50 seconds** after power is applied to the Control or from exiting Programming mode, **OR**
2. After power-up, enter the **Installer Code (4112) + 800** (This method disabled if Program mode is exited using *98.) to enter **Expert Programming** mode or **Installer Code (4112) + 888** to enter **Voice Prompt Programming** mode.

Note: If a different Installer Code has been programmed, use that code to enter the Programming mode. Once you have entered the Program mode, data field *20 (the first data field in the system) will be displayed and both keypad LEDs will flash.

Programming a Data Field

1. Press [*] + Field No. (for example, *21), followed by the required entry.
2. When you have completely programmed a data field, the keypad will “beep” three times and then automatically display the next data field in sequence. To go to a different field, press [*] plus the desired field number.
3. If the number of digits that will be entered in a data field is less than the maximum number of digits available (e.g. phone number field), enter the desired data, then press [*] to advance to the next data field.
4. If a nonexistent field has been entered, the keypad will display “EE”. Simply re-enter [*] plus a valid field number.

To view a data field without making changes: Enter [#] + **Field No.** Data will be displayed for that field.

To delete an entry in a field: Enter [*] + Field No. + [*]. (Applies only to fields *40–*44, *88 and *94).

Interactive Mode Programming (*56, *80, *81, *83, *84, *85)

Press [*] + **interactive mode No.** (for example, *56). The keypad will display the first of a series of prompts. A detailed procedure (with displays of prompts) is provided in later sections of this manual.

Interactive Mode	Used to Program
*56 Enhanced Zone Programming Mode	Zone characteristics, report codes, and serial numbers
*80 Device Programming Menu Mode	Powerline Carrier Devices
*81 Zone List Menu Mode	Zone Lists for powerline carrier activation
*83 Enhanced Sequential Mode	5800 Series transmitter serial numbers
*84 Assign Zone Voice Descriptors	Voice descriptors for each zone
*85 Record Custom Voice Descriptors	Up to 5 custom voice descriptors for zones

Loading Factory Defaults

To load the factory defaults, enter the Programming mode, press *97, then press number 1, 2, 3, or 4 to select from default tables 1-4 at the back of this manual, or press “0” if you are not selecting a default table.



If a default table is loaded, any data that has already been programmed into the system will be changed according to the default table selected!

*96 resets all subscriber account numbers and CSID in preparation for an initial download.

Exiting Program Mode

*98 inhibits re-entry into the Expert or Voice Prompt Programming modes using the Installer Code.

*99 allows re-entry into the Expert Program mode using **Installer Code (4112) + 800** or into the **Voice Prompt Programming** mode using **Installer Code (4112) + 888**.

Note: After exiting program mode (or upon power-up), the system takes up to a minute to reset. To bypass the reset delay, press [#] + [0].

Zone Response Type Definitions

General Information

During programming, you must assign a zone type to each zone, which defines the way in which the system responds to faults in that zone. Zone types are defined below.

Type 00 Zone type 00 is used to program a zone that is not used.
Zone Not Used

Type 01 Zone type 01 is usually assigned to sensors or contacts on primary entry and exit doors.
Entry/Exit Burglary #1



Zone Characteristics:

- Entry delay #1 is programmable from 30-240 seconds (field *35).
- Exit delay is independently programmable from 45-120 seconds (field *34).
- Exit and entry delays when armed in AWAY or STAY mode.
- No entry delay when armed in STAY NO DELAY or AWAY NO DELAY mode.
- Exit delay regardless of the arming mode selected.

Type 02 Zone type 02 is usually assigned to sensors or contacts on which secondary entry and exit doors that might be further from the keypad (typically used for a garage, loading dock, or basement door).
Entry/Exit Burglary #2



Zone Characteristics:

- Entry delay #2 is programmable from 30-240 seconds (field *36).
- Exit delay is independently programmable from 45-120 seconds (field *34).
- Secondary entry delay, if armed in the AWAY or STAY mode.
- No entry delay when armed in the STAY NO DELAY or AWAY NO DELAY mode.
- Exit delay begins regardless of the arming mode selected.

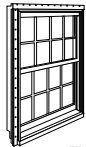

Type 03 Zone type 03 is usually assigned to all sensors or contacts on exterior doors and windows. **Zone Characteristics:**

- Instant alarm, when armed in AWAY, STAY, STAY NO DELAY, or AWAY NO DELAY mode.

Type 04 Zone type 04 is usually assigned to a zone covering an entry area (i.e.: foyer, lobby, or hallway) that one must pass upon entry (after faulting the entry/exit zone) to reach the keypad. It provides an instant alarm if the entry/exit zone is not violated first, and protects an area in the event an intruder has hidden on the premises before the system is armed, or gains access to the premises through an unprotected area.
Interior, Follower



Zone Characteristics:

- Delayed alarm (using the programmed entry/exit time) if entry/exit (types 01 or 02) or interior-with-delay (type 10) zone is faulted first.
- Instant alarm in all other situations.
- Active when armed in AWAY or AWAY NO DELAY mode.
- Bypassed automatically when armed in STAY or STAY NO DELAY mode.

Zone Response Type Definitions

Type 05
**Trouble by Day/
Alarm by Night**

Zone type 05 is usually assigned to a zone that contains foil-protected doors or windows or covers a sensitive area (i.e.: stock room, drug supply room, etc.) It can also be used on a sensor or contact in an area where immediate notification of an entry is desired.

Zone Characteristics:

- Instant alarm, when armed in AWAY, STAY, STAY NO DELAY, or AWAY NO DELAY (night) mode.
- Provides a latched trouble sounding from the keypad and, if desired, a central station report during the disarmed state (day).

Type 06
**24-hour
Silent Alarm**

Zone type 06 is usually assigned to a zone containing an Emergency button (silent emergency).

Zone Characteristics:

- Sends a report to the central station but provides no keypad display or sounding.

Type 07
**24-hour
Audible
Alarm**

Zone type 07 is usually assigned to a zone containing an Emergency button (audible emergency).

Zone Characteristics:

- Sends a report to the central station, and provides alarm sounds externally and at the keypad.

Type 08
**24-hour
Auxiliary Alarm**

Zone type 08 is usually assigned to a zone containing a button for use in personal emergencies or to a zone containing monitoring devices (i.e.: water or temperature sensors, etc.).

Zone Characteristics:

- Sends a report to the central station and provides an alarm sound at the keypad. (No bell output is provided and there is no keypad timeout.)

Type 09
**Supervised
Fire**

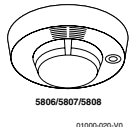

Zone type 09 can be assigned to any wireless zone used as a fire zone. This zone type is always active and cannot be bypassed.

Zone Characteristics:

- Bell output will pulse when this zone type is alarmed.

Type 10
Interior w/Delay

Zone type 10 is bypassed when the panel is armed in the STAY or STAY NO DELAY mode.

Zone Characteristics:

- Entry delay #1 (with programmed entry time) when armed in the AWAY mode.
- Entry delay begins whenever sensors in this zone are violated, regardless of whether an entry/exit delay zone was tripped first.
- No entry delay when armed in the AWAY NO DELAY mode.
- Exit delay regardless of the arming mode selected.

Zone Response Type Definitions

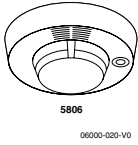

Type 16 Supervised Fire with Verification

Zone type 16 can be assigned to any wireless zone. It can not be used with heat detectors, combination heat/smoke detectors, wireless sensors or fire pull stations. This zone type is always active and can not be bypassed.

Zone Characteristics:

- Provides a fire alarm when zone is alarmed, but only after the alarm has been verified.
- System verifies alarm by delaying reporting and control panel alarm sounding for 30 seconds after alarm is detected. If the zone remains faulted after 30 seconds a fire alarm is provided. If any other fire zone is faulted during the 30 second delay window a fire alarm is immediately provided for that zone. An alarm for original fire zone will also be provided if that zone is still faulted afterward. If there are no fire alarms after the 30 second delay expires, the system will open a 60 second window. If any fire zone is faulted during that window a fire alarm will immediately be provided for that zone.
- Bell output will pulse following alarm verification

Type 20 Arm-Stay

Zone type 20 is a special-purpose zone type used with 5800 Series wireless pushbutton units.

Zone Characteristics:

- Exit delay regardless of the arming mode selected.
- System is armed in the STAY mode when the zone is activated.
- Zone number is sent to the central station as a user number when arming or disarming.

Type 21 Arm-Away

Zone type 21 is a special-purpose zone type used with 5800 Series wireless pushbutton units.

Zone Characteristics:

- System is armed in the AWAY mode when the zone is activated.
- Zone number is sent to the central station as a user number when arming or disarming.

Type 22 Disarm

Zone type 22 is a special-purpose zone type used with 5800 series wireless pushbutton.

Zone Characteristics:

- Disarms the system when the zone is activated.

Type 23 No Alarm Response

Zone type 23 can be used on a zone when a Powerline Carrier Device (e.g., X-10) action is desired, but with no accompanying alarm (e.g., front door light).

Type 24 Silent Burglary

Zone type 24 is usually assigned sensors or contacts on exterior doors and windows where bells and/or sirens are NOT desired.

Zone Characteristics:

- Instant alarm, with NO audible indication when is armed in the AWAY, STAY, STAY NO DELAY, or AWAY NO DELAY mode.
- Report sent to the central station.

Note: Keypad beeps if the zone is faulted when system is disarmed and Chime mode is on.

Data Field Descriptions

The following pages list all data fields in this Control (in numerical order). Use the blank programming form to record the data for this installation. Note that both keypad LEDs flash while in Programming mode.

Note: Entering a number other than the one specified will give unpredictable results.

LYNXR-ENSIA validates the data entry for the Fields listed below. If data entered is not within valid range, the control will emit a long beep indicating that entry is rejected. The control will then substitute the default value for the invalid entry and the default value will be displayed on the keypad. The control will then advance to the next field.

Field	Name	Default Value	Valid Range
*34	Exit Delay	60	45-97
*35	Entry Delay 01	30	30-99
*36	Entry Delay 02	30	30-99
*50	Burglary Dial Delay	2	1-3
*57	False Alarm Options	7	0-7
*59	Exit Error Report Code	1	1-F
*64	Test Report Code	10	10-FF
*68	Cancel Report Code	10	10-FF
*69	Recent Closing Report Code	1	1-F
*76	Test Restore Report	10	10-FF
*92	Swinger Shutdown	1	1-2

*20	Installer Code Enter 4 digits, 0-9	The Installer Code is used to enter the 4-digit Master Security Code. See "Master Code" in the <i>System Operation</i> section for procedure. Note: LYNX does not allow duplication of Installer code. If a duplicate code is entered the entry is rejected and LYNX issues single long beep indicating rejection. The old installer code remains unchanged.
*21	Quick Arm Enable 0 = do not allow quick arm 1 = allow quick arm	If enabled, security code is not required to arm the system. The user simply presses and holds down the AWAY or STAY key to arm.
*22	Keypad Backlight Timeout 0 = no timeout; always backlight keys 1 = turn backlighting off after inactivity	This option allows the choice of either always backlighting the keypad or turning the backlighting off after 10 seconds of keypad inactivity.
*23	Forced Bypass 0 = no forced bypass 1 = provide automatic bypass of all open (faulted) zones	All zones bypassed by this function will be displayed after the bypass is initiated. Note: UL installations: must be 0 (no forced bypass)
*24	RF House ID Code 00 = disable all wireless keypad usage 01-31 = House ID	The House ID identifies receivers and wireless keypads. If a 5804BD/5804BDV Transmitter is to be used, a House ID Code MUST be entered, and the keypad should be set to the same ID.
*25	Powerline Carrier Device (X-10) House ID 0 = A 4 = E 8 = I # + 12 = M 1 = B 5 = F 9 = J # + 13 = N 2 = C 6 = G # + 10 = K # + 14 = O 3 = D 7 = H # + 11 = L # + 15 = P	Powerline Carrier Devices require a House ID. This field identifies this House ID to the Control. The Powerline Carrier Devices are programmed in field *80.
*26	Chime by Zone 0 = no (chimes on fault of any entry/exit or perimeter zone when Chime mode is activated) 1 = yes (chimes on fault of those zones assigned to Zone List 3 when Chime mode on)	This option allows the installer to define the specific zones intended to chime when faulted while the system is in Chime mode. If enabled, these zones are defined in zone list 3 (see *81 <i>Zone List Menu Mode</i>).
*27	Real Time Clock Display 0 = do not display the time 1 = display the time	Refer to the User's Manual for setting the clock time and date.
*29	Daylight Savings Time Start/End Month 0, 0 = no daylight saving time used 1-12 = start month and end month	Enter # + 10 for 10, # + 11 for 11, and # + 12 for 12.
*30	Daylight Savings Time Start/End Week 0 = disable 4 = fourth weekend 1 = first weekend of month 5 = last weekend 2 = second weekend 6 = next to last 3 = third weekend 7 = 3 rd from last	Enter the appropriate start and end weekend of the month.

Data Field Descriptions

<p>*31</p>	<p>Single Alarm Sounding Per Zone (per armed period) 0 = Alarm Sounding Per Zone will be the same as the Swinger Shutdown” set in field *92 1 = limit alarm sounding to once per arming period for a given zone</p>	<p>UL installations: must be 0 This field applies only to burglary zones (zone response types 1-5, 10), and affects long range radio reporting but does not affect central station reporting. Notes: 1. This field applies only to the bell and does not affect keypad sounds. 2. If swinger shutdown occurs (see Swinger Shutdown in Field *92), the number of alarm soundings on a given zone will be limited by the setting selected in Field *92.</p>
<p>*32</p>	<p>Fire Sounder Timeout 0 = yes, fire sounder timeout after time programmed in field *33 1 = no fire sounder timeout; continue sounding until manually turned off</p>	<p>This Control complies with NFPA requirements for temporal pulse sounding of fire notification appliances. Temporal pulse sounding for a fire alarm consists of the following: 3 pulses – pause – 3 pulses – pause – 3 pulses. . .</p>
<p>*33</p>	<p>Alarm Bell Timeout 0 = No timeout 2 = 8 min 4 = 16 min 1 = 4 min 3 = 12 min</p>	<p>This field determines whether the external sounder will shut off after time allowed, or continue until manually turned off. UL installations: must be set for a minimum of 4 min (option 1)</p>

DELAY PROGRAMMING (*34–*36)

NOTE: The control validates the data entered in these fields. If the selection is not valid the control will emit a single long beep indicating that the selection has been rejected. The control replaces the selection with the default value which is displayed on the keypad.

<p>*34</p>	<p>Exit Delay Entries from 45-97</p> <table border="0"> <thead> <tr> <th>Entered Value</th> <th>Delay in Seconds</th> </tr> </thead> <tbody> <tr> <td>45-96</td> <td>45-96</td> </tr> <tr> <td>97</td> <td>120</td> </tr> </tbody> </table>	Entered Value	Delay in Seconds	45-96	45-96	97	120	<p>The system will wait the time entered before sounding an alarm if the exit door is left open after the system has been armed. UL installations: must be set for a maximum of 60 seconds. Note: The control validates the data entered in this field. If the selection is not valid the control will emit a single long beep indicating that the selection has been rejected. The control replaces the selection with the default value “60”, which is displayed on the keypad, and advances to the next field. SIA: Exit Delay must be set to a minimum of 45 seconds.</p>				
Entered Value	Delay in Seconds											
45-96	45-96											
97	120											
<p>*35</p>	<p>Entry Delay 01 Entries from 30-99</p> <table border="0"> <thead> <tr> <th>Entered Value</th> <th>Delay in Seconds</th> </tr> </thead> <tbody> <tr> <td>30-96</td> <td>30-96</td> </tr> <tr> <td>97</td> <td>120</td> </tr> <tr> <td>98</td> <td>180</td> </tr> <tr> <td>99</td> <td>240</td> </tr> </tbody> </table>	Entered Value	Delay in Seconds	30-96	30-96	97	120	98	180	99	240	<p>The system will wait the time entered before sounding alarm upon entering if system is not disarmed. UL installations: must be set for a maximum of 45 seconds. Note: The control validates the data entered in this field. If the selection is not valid the control will emit a single long beep indicating that the selection has been rejected. The control replaces the selection with the default value “30”, which is displayed on the keypad, and advances to the next field. SIA The Entry delay must be set to a minimum of 30 seconds. The sum of entry delay 1 entered in Field *35 and the burglary abort window entered in *50 should not exceed 1 minute.</p>
Entered Value	Delay in Seconds											
30-96	30-96											
97	120											
98	180											
99	240											
<p>*36</p>	<p>Entry Delay 02 Entries from 30-99</p> <table border="0"> <thead> <tr> <th>Entered Value</th> <th>Delay in Seconds</th> </tr> </thead> <tbody> <tr> <td>30-96</td> <td>30-96</td> </tr> <tr> <td>97</td> <td>120</td> </tr> <tr> <td>98</td> <td>180</td> </tr> <tr> <td>99</td> <td>240</td> </tr> </tbody> </table>	Entered Value	Delay in Seconds	30-96	30-96	97	120	98	180	99	240	<p>The system will wait the time entered before sounding alarm upon entering, if the system is not disarmed UL installations: must be set for a maximum of 45 seconds Note: The control validates the data entered in this field. If the selection is not valid the control will emit a single long beep indicating that the selection has been rejected. The control replaces the selection with the default value “30”, which is displayed on the keypad, and advances to the next field. SIA The Entry delay must be set to a minimum of 30 seconds. The sum of entry delay 2 entered in Field *36 and the burglary abort window entered in *50 should not exceed 1 minute.</p>
Entered Value	Delay in Seconds											
30-96	30-96											
97	120											
98	180											
99	240											
<p>*38</p>	<p>Confirmation of Arming Ding 0 = no arming confirmation ding after arming system by LYNXR keypad or RF keypad 1 = arming confirmation ding after arming system by LYNXR keypad or RF keypad 2 = arming confirmation ding after arming from RF keypad only</p>	<p>Confirmation of arming is provided by a 1/2 second external sounder “ding” . The confirmation ding only sounds when LYNX is Armed Away or disarmed after being Armed Away. If Option 1 is selected, confirmation of arming is provided by a 1/2 second sounder “ding” that sounds when closing report is sent, or at the end of exit delay. If Option 2 is selected the external sounder “ding” occurs immediately after arming from an RF keypad. Note: If LYNX is armed by RF button (key fob), a confirmation ding occurs immediately after arming regardless of field *38 settings. If LYNX is disarmed by RF button (key fob), additional disarming confirmation ding is provided. The ding occurs immediately after disarming and is longer than arming confirmation ding.</p>										

Data Field Descriptions

*39	<p>Cross Zone Timer</p> <table border="0"> <thead> <tr> <th>Value</th> <th>Time Window</th> </tr> </thead> <tbody> <tr><td>0 =</td><td>No Cross Zoning</td></tr> <tr><td>1 =</td><td>15 seconds</td></tr> <tr><td>2 =</td><td>30 seconds</td></tr> <tr><td>3 =</td><td>45 seconds</td></tr> <tr><td>4 =</td><td>60 seconds</td></tr> <tr><td>5 =</td><td>1 minute, 15 seconds</td></tr> <tr><td>6 =</td><td>1 minute, 30 seconds</td></tr> <tr><td>7 =</td><td>1 minute, 45 seconds</td></tr> <tr><td>8 =</td><td>2 minutes</td></tr> <tr><td>9 =</td><td>2 minute, 15 seconds</td></tr> <tr><td># + 10 =</td><td>2 minute, 30 seconds</td></tr> <tr><td># + 11 =</td><td>2 minute, 45 seconds</td></tr> <tr><td># + 12 =</td><td>3 minutes</td></tr> <tr><td># + 13 =</td><td>3 minute, 15 seconds</td></tr> <tr><td># + 14 =</td><td>3 minute, 30 seconds</td></tr> <tr><td># + 15 =</td><td>3 minute, 45 seconds</td></tr> </tbody> </table>	Value	Time Window	0 =	No Cross Zoning	1 =	15 seconds	2 =	30 seconds	3 =	45 seconds	4 =	60 seconds	5 =	1 minute, 15 seconds	6 =	1 minute, 30 seconds	7 =	1 minute, 45 seconds	8 =	2 minutes	9 =	2 minute, 15 seconds	# + 10 =	2 minute, 30 seconds	# + 11 =	2 minute, 45 seconds	# + 12 =	3 minutes	# + 13 =	3 minute, 15 seconds	# + 14 =	3 minute, 30 seconds	# + 15 =	3 minute, 45 seconds	<p>Sets the maximum amount of time in which two cross zones must be tripped in an armed system to send an alarm message to the Central Station. If only one cross zone is tripped during this time, a trouble message (CID code 380) for that zone is sent to the Central Station. Program Zone list 2 (using *81 Zone List Menu Mode) with the two zones that are to be cross zoned.</p> <p>Notes: (1) If option *39 is set to "0" (no cross zoning) then Zone List 2 can be used for other purposes. (2) Cross zoning will be disabled during entry and exit delays, if there is already an alarm in the system, if one or both of the 2 cross zones is bypassed. If one of the 2 cross zones faults and remains faulted after the cross zone time interval, the second cross zone can go into alarm immediately, even after the cross zone time. This is to detect scenarios involving multiple break-ins of a premises.</p> <p>UL This option is not for use in UL installations.</p>
Value	Time Window																																			
0 =	No Cross Zoning																																			
1 =	15 seconds																																			
2 =	30 seconds																																			
3 =	45 seconds																																			
4 =	60 seconds																																			
5 =	1 minute, 15 seconds																																			
6 =	1 minute, 30 seconds																																			
7 =	1 minute, 45 seconds																																			
8 =	2 minutes																																			
9 =	2 minute, 15 seconds																																			
# + 10 =	2 minute, 30 seconds																																			
# + 11 =	2 minute, 45 seconds																																			
# + 12 =	3 minutes																																			
# + 13 =	3 minute, 15 seconds																																			
# + 14 =	3 minute, 30 seconds																																			
# + 15 =	3 minute, 45 seconds																																			

DIALER PROGRAMMING (*40-*50)

Fields *40, *41, *42: Enter up to the number of digits shown. Enter 0-9, # + 11 for [*]; # + 12 for [#]; # + 13 for a pause (2 seconds)

NOTE: Whenever AAV is used, primary (field *41) and secondary (field *42) phone numbers should be preceded with the call waiting disable command. Otherwise, there is the possibility of connection of the third party to LYNX during AAV mode.

*40	<p>PABX Access Code/Call Waiting Disable Enter up to 6 digits if PABX is needed to access an outside line. or Enter "# + 11 + 7 + 0" to program the touch-tone sequence "*70" and cancel call waiting.</p>	<p>If fewer than 6 digits need to be entered, exit by pressing [*]. To clear entries from field, press *40*.</p> <p>Call Waiting: If the subscriber's phone service has "call waiting" (and is not using PABX), enter the touch-tone sequence "*70" (or similar depending on the phone service). by programming "# + 11 + 7 + 0" as the PABX entry to disable "call waiting" during control panel calls. You must also enable the Call Waiting Cancel option in field *47.</p> <p>If the subscriber does not have "call waiting" and is not using PABX, make no entry in this field.</p> <p>Important Note: If Call Wait Cancel is disabled in Field *47, and Call Wait Disable command is entered in Field *40, this will prevent successful communication to the central station when used on a non-call waiting line.</p> <p>Note: PABX number and operation of the control panel with a PBX system cannot be used if the Call Waiting Cancel Disable option has been enabled in Field *47.</p>
41	<p>Primary Phone No. Enter up to 20 digits.</p>	<p>If fewer than 20 digits entered, exit by pressing []. To clear entries from field, press *41*.</p> <p>Note: Backup reporting (8 attempts are made to the secondary phone number if no kissoff is received after 8 attempts to the primary number) is automatic only if there is a secondary phone number (field *42).</p>
42	<p>Secondary Phone No. Enter up to 24 digits.</p>	<p>If fewer than 24 digits entered, exit by pressing []. To clear entries from field, press *42*. See backup reporting note for field *41. If using the paging feature, enter the pager phone number here.</p>



All four digits of the Subscriber Account number must be entered in Fields *43 and *44. If ten digit format is selected in *48 (option 5), all ten digits of the Subscriber Account number must be entered.

Fields *43 and *44:

Enter [*] as the fourth digit if a 3-digit account number (for 3+1 dialer reporting format) is used. Enter 0 as the first digit of a 4-digit account number for Nos. 0000-0999. Enter [*] as the fifth digit if a 4-digit account number (for 3+1, CID®) is used. Exit field by pressing [*] if only 3 digits are used. To clear entries from field, press *43* or *44*. See blank Programming Form for examples of account number entries. If using the paging feature, do not enter a leading 0 in the subscriber account number, and do not use digits A-F anywhere in the number. Some paging systems provide voice mail capability, which is activated by a leading 0 in the message. Enter digits 0-9; # +11=B; # +12=C; # +13=D; # +14=E; or # +15=F.

Data Field Descriptions

*43	Primary Subs Account No. Enter a four or ten digit account number.	Enter the primary subscriber account number. To clear entries from field, press *43*.
*44	Secondary Subs Account No. Enter a four or ten digit account number.	Enter the secondary subscriber account number. To clear entries from field, press *44*.

Field 46: Enter up to 24 digits. Do not fill unused spaces. Enter 0-9, #+11 for '*'; #+12 for '#'; #+13 for a pause (2 seconds).

*46	"Follow Me Reminder" Phone Number Enter up to 24 digits.	<p>This option allows the user to schedule a time driven message. When activated the system will dial the phone number programmed and deliver a voice message (custom words 72, 73 and 74). This option is only supported when the pager or follow me feature is enabled in field *49 (option 6-9 or 10-13).</p> <p>If using the Follow Me Reminder feature, enter the phone number here. If fewer than 24 digits are entered, exit by pressing [*]. To clear entries from the field press *46*.</p> <p>The telephone message can be terminated (acknowledged) by pressing any key on the telephone keypad. Pressing any key on the local LYNXR-ENSIA keypad will terminate (acknowledge) both the follow me and the local reminder announcements.</p> <p>Note: The follow me reminder announcement will be terminated if any other event requires the system to dial out or if an audible alarm has occurred.</p>																													
*47	Phone System Select <table border="1" style="width: 100%; border-collapse: collapse;"> <thead> <tr> <th rowspan="2">Central Station</th> <th colspan="4">Dialing Mode</th> </tr> <tr> <th>Pulse</th> <th>Tone</th> <th>Pulse</th> <th>Tone</th> </tr> </thead> <tbody> <tr> <td>No WATS</td> <td>0 = No Speaker Phone Call Wait Cancel Disabled</td> <td>1 = No Speaker Phone Call Wait Cancel Disabled</td> <td>4 = With Speaker Phone Call Wait Cancel Disabled</td> <td>5 = With Speaker Phone Call Wait Cancel Disabled</td> </tr> <tr> <td>WATS</td> <td>2 = No Speaker Phone Call Wait Cancel Disabled</td> <td>3 = No Speaker Phone Call Wait Cancel Disabled</td> <td>6 = With Speaker Phone Call Wait Cancel Disabled</td> <td>7 = With Speaker Phone Call Wait Cancel Disabled</td> </tr> <tr> <td>No WATS</td> <td>8 = No Speaker Phone Call Wait Cancel Enabled</td> <td>9 = No Speaker Phone Call Wait Cancel Enabled</td> <td>12 = with Speaker Phone Call Wait Cancel Enabled</td> <td>13 = With Speaker Phone Call Wait Cancel Enabled</td> </tr> <tr> <td>WATS</td> <td>10 = No Speaker Phone Call Wait Cancel Enabled</td> <td>11 = No Speaker Phone Call Wait Cancel Enabled</td> <td>14 = With Speaker Phone Call Wait Cancel Enabled</td> <td>15 = With Speaker Phone Call Wait Cancel Enabled</td> </tr> </tbody> </table>	Central Station	Dialing Mode				Pulse	Tone	Pulse	Tone	No WATS	0 = No Speaker Phone Call Wait Cancel Disabled	1 = No Speaker Phone Call Wait Cancel Disabled	4 = With Speaker Phone Call Wait Cancel Disabled	5 = With Speaker Phone Call Wait Cancel Disabled	WATS	2 = No Speaker Phone Call Wait Cancel Disabled	3 = No Speaker Phone Call Wait Cancel Disabled	6 = With Speaker Phone Call Wait Cancel Disabled	7 = With Speaker Phone Call Wait Cancel Disabled	No WATS	8 = No Speaker Phone Call Wait Cancel Enabled	9 = No Speaker Phone Call Wait Cancel Enabled	12 = with Speaker Phone Call Wait Cancel Enabled	13 = With Speaker Phone Call Wait Cancel Enabled	WATS	10 = No Speaker Phone Call Wait Cancel Enabled	11 = No Speaker Phone Call Wait Cancel Enabled	14 = With Speaker Phone Call Wait Cancel Enabled	15 = With Speaker Phone Call Wait Cancel Enabled	<p>This option is used to enter the correct type of phone dialing (pulse or tone), and to select the correct WATS line option for the Central Station. It is also to activate the Speaker Phone option and to disable call waiting.</p> <p>Call waiting warning tones can interfere with Central stations reporting. The Call Waiting Cancel option should be selected if the reporting phone line has call waiting service. The Call Waiting Cancel command must also be programmed in Field *40. If the Call Waiting Cancel feature is enabled, make sure to enter Call Waiting Cancel command in Field *40. The command depends on a telephone service provider.</p> <p>Important Note: If Call Wait Cancel is disabled in Field *47, and Call Waiting Disable command is entered in Field *40, this will prevent successful communication to the central station when used on a non-call waiting line.</p> <p>Notes: (1) PABX number and operation of the control panel with a PBX system cannot be used if the Call Waiting Cancel option has been enabled in Field *47. (2) If using pulse dialing, you must enter the numbers slowly in order to allow the pulse dialer time to operate.</p>
Central Station	Dialing Mode																														
	Pulse	Tone	Pulse	Tone																											
No WATS	0 = No Speaker Phone Call Wait Cancel Disabled	1 = No Speaker Phone Call Wait Cancel Disabled	4 = With Speaker Phone Call Wait Cancel Disabled	5 = With Speaker Phone Call Wait Cancel Disabled																											
WATS	2 = No Speaker Phone Call Wait Cancel Disabled	3 = No Speaker Phone Call Wait Cancel Disabled	6 = With Speaker Phone Call Wait Cancel Disabled	7 = With Speaker Phone Call Wait Cancel Disabled																											
No WATS	8 = No Speaker Phone Call Wait Cancel Enabled	9 = No Speaker Phone Call Wait Cancel Enabled	12 = with Speaker Phone Call Wait Cancel Enabled	13 = With Speaker Phone Call Wait Cancel Enabled																											
WATS	10 = No Speaker Phone Call Wait Cancel Enabled	11 = No Speaker Phone Call Wait Cancel Enabled	14 = With Speaker Phone Call Wait Cancel Enabled	15 = With Speaker Phone Call Wait Cancel Enabled																											
*48	Report Format for Primary/Secondary <table border="1" style="width: 100%; border-collapse: collapse;"> <thead> <tr> <th>Primary</th> <th>Secondary</th> </tr> </thead> <tbody> <tr> <td>See choices below</td> <td>See choices below</td> </tr> <tr> <td>0 = 3+1; 4+1 ADEMCO Low Speed Standard</td> <td></td> </tr> <tr> <td>1 = 3+1; 4+1 Radionics Standard</td> <td></td> </tr> <tr> <td>2 = 4+2 ADEMCO Low Speed Standard</td> <td></td> </tr> <tr> <td>3 = 4+2 Radionics Standard</td> <td></td> </tr> <tr> <td>5 = ADEMCO Contact ID® Reporting with 10-digit subscriber account number</td> <td></td> </tr> <tr> <td>6 = 4+2 ADEMCO Express</td> <td></td> </tr> <tr> <td>7 = ADEMCO Contact ID® Reporting with 4-digit subscriber account number</td> <td></td> </tr> <tr> <td>8 = 3+1; 4+1 ADEMCO Low Speed Expanded</td> <td></td> </tr> <tr> <td>9 = 3+1; 4+1 Radionics Expanded</td> <td></td> </tr> </tbody> </table>	Primary	Secondary	See choices below	See choices below	0 = 3+1; 4+1 ADEMCO Low Speed Standard		1 = 3+1; 4+1 Radionics Standard		2 = 4+2 ADEMCO Low Speed Standard		3 = 4+2 Radionics Standard		5 = ADEMCO Contact ID® Reporting with 10-digit subscriber account number		6 = 4+2 ADEMCO Express		7 = ADEMCO Contact ID® Reporting with 4-digit subscriber account number		8 = 3+1; 4+1 ADEMCO Low Speed Expanded		9 = 3+1; 4+1 Radionics Expanded		<p>Enter * as the 4th digit of *43 through *44, if 3+1 dialer reporting is to be used. (For an explanation of these formats, see the System Communication section of this manual.)</p> <p>Notes: (1) The maximum number of alarms is determined by field *92. (2) If Option 5 is selected a 10-digit account number must be entered in Fields *43 or *44. (3) Option 5 or 7 (ADEMCO Contact ID® Reporting) must be selected for AVM.</p>							
Primary	Secondary																														
See choices below	See choices below																														
0 = 3+1; 4+1 ADEMCO Low Speed Standard																															
1 = 3+1; 4+1 Radionics Standard																															
2 = 4+2 ADEMCO Low Speed Standard																															
3 = 4+2 Radionics Standard																															
5 = ADEMCO Contact ID® Reporting with 10-digit subscriber account number																															
6 = 4+2 ADEMCO Express																															
7 = ADEMCO Contact ID® Reporting with 4-digit subscriber account number																															
8 = 3+1; 4+1 ADEMCO Low Speed Expanded																															
9 = 3+1; 4+1 Radionics Expanded																															

Data Field Descriptions

<p>*49</p>	<p>Split/Dual Reporting</p> <table border="1"> <thead> <tr> <th>To Primary</th> <th>To Secondary</th> </tr> </thead> <tbody> <tr> <td>0 = All reports</td> <td>None, unless primary fails, then all</td> </tr> <tr> <td>1 = Alarms, Restore, Cancel*</td> <td>Others</td> </tr> <tr> <td>2 = All except Open/Close, Test</td> <td>Open/Close, Test</td> </tr> <tr> <td>3 = Alarms, Restore, Cancel</td> <td>All</td> </tr> <tr> <td>4 = All except Open/Close, Test</td> <td>All</td> </tr> <tr> <td>5 = All reports</td> <td>All</td> </tr> </tbody> </table> <table border="1"> <thead> <tr> <th>To Primary</th> <th>To Paging Number</th> </tr> </thead> <tbody> <tr> <td>6 = All reports except Open/Close</td> <td>Alarms, Open/Close ‡, Troubles</td> </tr> <tr> <td>7 = All reports</td> <td>Alarms, Troubles</td> </tr> <tr> <td>8 = All reports</td> <td>Alarms, Open/Close ‡, Troubles</td> </tr> <tr> <td>9 = All reports except Open/Close</td> <td>Open/Close ‡</td> </tr> </tbody> </table> <table border="1"> <thead> <tr> <th>To Primary</th> <th>To Follow Me System Phone Number</th> </tr> </thead> <tbody> <tr> <td>10=All reports except Open/Close</td> <td>Alarms, Open/Close ‡, Troubles</td> </tr> <tr> <td>11 = All reports</td> <td>Alarms, Troubles</td> </tr> <tr> <td>12=All reports</td> <td>Alarms, Open/Close ‡, Troubles</td> </tr> <tr> <td>13=All reports except Open/Close</td> <td>Open/Close ‡</td> </tr> </tbody> </table> <p>*Recent close report is sent to primary number</p> <p>‡ Will report Users 0, 5-8, and, if using wireless button-type devices, will report the zone number of the arm or disarm button 26-33. All other zones and users are not reported.</p>	To Primary	To Secondary	0 = All reports	None, unless primary fails, then all	1 = Alarms, Restore, Cancel*	Others	2 = All except Open/Close, Test	Open/Close, Test	3 = Alarms, Restore, Cancel	All	4 = All except Open/Close, Test	All	5 = All reports	All	To Primary	To Paging Number	6 = All reports except Open/Close	Alarms, Open/Close ‡, Troubles	7 = All reports	Alarms, Troubles	8 = All reports	Alarms, Open/Close ‡, Troubles	9 = All reports except Open/Close	Open/Close ‡	To Primary	To Follow Me System Phone Number	10=All reports except Open/Close	Alarms, Open/Close ‡, Troubles	11 = All reports	Alarms, Troubles	12=All reports	Alarms, Open/Close ‡, Troubles	13=All reports except Open/Close	Open/Close ‡	<p>This field is used to select a reporting option as follows: Enter: 0 - 5 when reporting to telephone receivers. 6 - 9 when reporting to a pager is desired. 10 - 13 when reporting to an auxiliary telephone receiver.</p> <p>Pager Report Format Options 6-9 send reports to the primary phone number, in a format defined in Field *48, and send reports to a pager, which has its phone number entered as the secondary phone number in Field *42. The pager report is a 7-digit code, with optional 16-digit prefix, in the following format: AAAAAAAAAAAAAAAA-EEE-0NNN where: AAA = Optional 16 digits for PIN number, etc. See Field *88 for full description of these characters. EEE = 3-digit Event Code as follows: 911 = Alarm (NN = zone number) 101 = Open, system disarmed (NN = user no.) 102 = Close, system armed (NN = user no.) 811 = Trouble (NN = zone no.) 0 = Always displayed before 2-digit user/zone no. NNN = 3-digit user number or zone number, depending on the type of event (EEE) that occurred.</p> <p>Follow Me System Report Format Options 10-13 send reports to the primary phone number, in a format defined in Field *48, and sends voice message to the secondary phone number entered in Field *42.</p> <p>The message is a repeatable system status announcement. If the manual paging option has been programmed in Field *87, the message will repeat "system, system.....".</p> <p>The message can be terminated by pressing any key on the telephone keypad.</p>
To Primary	To Secondary																																			
0 = All reports	None, unless primary fails, then all																																			
1 = Alarms, Restore, Cancel*	Others																																			
2 = All except Open/Close, Test	Open/Close, Test																																			
3 = Alarms, Restore, Cancel	All																																			
4 = All except Open/Close, Test	All																																			
5 = All reports	All																																			
To Primary	To Paging Number																																			
6 = All reports except Open/Close	Alarms, Open/Close ‡, Troubles																																			
7 = All reports	Alarms, Troubles																																			
8 = All reports	Alarms, Open/Close ‡, Troubles																																			
9 = All reports except Open/Close	Open/Close ‡																																			
To Primary	To Follow Me System Phone Number																																			
10=All reports except Open/Close	Alarms, Open/Close ‡, Troubles																																			
11 = All reports	Alarms, Troubles																																			
12=All reports	Alarms, Open/Close ‡, Troubles																																			
13=All reports except Open/Close	Open/Close ‡																																			
<p>*50</p>	<p>Burglary Abort Window 0 = No abort window 1 = 15-second abort window 2 = 30-second abort window 3 = 45-second abort window</p> <p>SIA Abort Window time options: 1 = 15 secs; 2 = 30 secs</p>	<p>This provides the option for an Abort Window for Burglary zone types that report to the central station. This feature allows time for the subscriber to avoid a false alarm transmission. This feature does not apply to zone type 9 or 16 alarms (Supervised Fire) or to 24-hour zone types 6, 7, and 8 (silent panic, audible alarm, auxiliary alarm), which are always sent as soon as they occur.</p> <p>SIA Guidelines: must be set to a minimum of 15 seconds</p> <p>SIA The sum of the burglary abort window entered in *50 and the entry delays entered in either Field *35 or *36 should not exceed 1 minute.</p> <p>UL Installations: Must be set to 0 (no abort window)</p> <p>Note: The control validates the data entered in this field. If the selection is not valid the control will emit a single long beep indicating that the selection has been rejected. The control replaces the selection with the default value "2", which is displayed on the keypad, and advances to the next field.</p>																																		
<p>*51</p>	<p>Periodic Test Report 0 = no test report 2 = weekly 1 = once every 24 hrs 3 = once every 30 days</p>	<p>Test report code entered in field *64 is sent.</p>																																		
<p>*52</p>	<p>First test Report Offset 0 = 24 hrs after exit program mode or download 1 = 6 hours after exit program mode or download 2 = 12 hrs after exit program mode or download 3 = 18 hrs after exit program mode or download</p>	<p>This is the time to first report from programming or downloading.</p>																																		
<p>*53</p>	<p>Sescoa/Radionics Select 0 = Radionics (0-9, B-F reporting) 1 = SESCOA (0-9 only reporting)</p>	<p>Select 0 for all other formats.</p>																																		
<p>*54</p>	<p>Lack of Usage Notification 0 = Disabled 4 = 90 days 1 = 1 day 5 = 180 days 2 = 7 days 6 = 365 days 3 = 27 days</p> <p>Note: There will be no local annunciation indicating that this report has been sent to the Central Station.</p>	<p>If enabled, notifies the central station if an end user is not operating their security system by sending a System Inactivity report 654. The report will be sent only to the Primary phone number and only if Contact ID® format was selected.</p> <p>Note: The report will follow the *49 = 0 rules, no matter which selection was made in *49.</p>																																		

Data Field Descriptions

<p>*57</p>	<p>False Alarm Options</p> <table border="1"> <thead> <tr> <th>Value</th> <th>Cancel Alarm Display</th> <th>Auto Stay Arming</th> <th>Exit Time Restart/Reset</th> </tr> </thead> <tbody> <tr> <td>0 =</td> <td>Disabled</td> <td>Disabled</td> <td>Disabled</td> </tr> <tr> <td>1 =</td> <td>Disabled</td> <td>Disabled</td> <td>Enabled</td> </tr> <tr> <td>2 =</td> <td>Disabled</td> <td>Enabled</td> <td>Disabled</td> </tr> <tr> <td>3 =</td> <td>Disabled</td> <td>Enabled</td> <td>Enabled</td> </tr> <tr> <td>4 =</td> <td>Enabled</td> <td>Disabled</td> <td>Disabled</td> </tr> <tr> <td>5 =</td> <td>Enabled</td> <td>Disabled</td> <td>Enabled</td> </tr> <tr> <td>6 =</td> <td>Enabled</td> <td>Enabled</td> <td>Disabled</td> </tr> <tr> <td>7 =</td> <td>Enabled</td> <td>Enabled</td> <td>Enabled</td> </tr> </tbody> </table>	Value	Cancel Alarm Display	Auto Stay Arming	Exit Time Restart/Reset	0 =	Disabled	Disabled	Disabled	1 =	Disabled	Disabled	Enabled	2 =	Disabled	Enabled	Disabled	3 =	Disabled	Enabled	Enabled	4 =	Enabled	Disabled	Disabled	5 =	Enabled	Disabled	Enabled	6 =	Enabled	Enabled	Disabled	7 =	Enabled	Enabled	Enabled	<p>Note: The control validates the data entered in this field. If the selection is not valid the control will emit a single long beep indicating that the selection has been rejected. The control replaces the selection with the default value "7", which is displayed on the keypad, and advances to the next field.</p> <p>Cancel Alarm Display This option enables the display of aborted and cancelled alarms on the LYNXR-ENSIA keypad. "CA" will be displayed.</p> <p>Notes:</p> <ol style="list-style-type: none"> 1. An abort occurs if the alarm panel is disarmed before it dials the alarm report to the central station. 2. A cancel occurs if the alarm panel is disarmed after the alarm is reported. 3. Zone types 5, 6 and 7 (panic zone types) and 24 (silent burglary) cannot be cancelled. <p>Auto Stay Arming If this feature is enabled and the control panel has been armed "Armed Away" at the LYNX keypad or RF keypad, the system will switch to the "Armed Stay" mode if the Exit Time has expired and no exit has been made.</p> <p>Exit Time Restart-Exit Delay Restart/Reset This option allows the systems to restart the exit delay time after arming in STAY mode by entering the User Code and pressing the STAY key (if quick arming is disabled) or by pressing the STAY key (if quick arming is enabled). This option also enables automatic exit delay reset, which resets exit delay if the entry/exit door is re-opened and closed before exit delay time expires after arming.</p> <p>Notes:</p> <ol style="list-style-type: none"> 1. This avoids the need to disarm and then re-arm the system after allowing someone to enter or exit. 2. Automatic Exit Delay Reset occurs only once during an armed period.
Value	Cancel Alarm Display	Auto Stay Arming	Exit Time Restart/Reset																																			
0 =	Disabled	Disabled	Disabled																																			
1 =	Disabled	Disabled	Enabled																																			
2 =	Disabled	Enabled	Disabled																																			
3 =	Disabled	Enabled	Enabled																																			
4 =	Enabled	Disabled	Disabled																																			
5 =	Enabled	Disabled	Enabled																																			
6 =	Enabled	Enabled	Disabled																																			
7 =	Enabled	Enabled	Enabled																																			
<p>*58</p>	<p>RF Jam Detection 0 = no jam detection; 1 = RF jam detection with event logging, but no central station report 2 = RF jam detection with event logging and with central station report (if trouble/restore report is enabled in fields *60, *71)</p>	<p>For Event Logging, Option 2 must be selected.</p> <p>If the control detects an RF jam condition, a "FAULT" message appears for zone 90. The Contact ID® code for RF Jam is 344.</p>																																				
<p>*59</p>	<p>Exit Error Report Code (Always enabled, a report code can be entered if reporting formats other than Contact ID® are used)</p>	<p>If the system is armed and an entry/exit or interior zone is still open after the exit delay time has expired, an alarm will sound at the keypad and external sounder (the keypad will also display "EA"), and the entry delay begins. If the system is disarmed before the end of the entry delay that immediately follows, the alarm sounding will stop and no message will be sent to the central station. The keypad will display "CA (CANCELED ALARM)" if the cancel display option was enabled in field *57.</p> <p>If the system is not disarmed before the end of the entry delay mentioned above, and an entry/exit or interior zone is still open, an "Exit Alarm" message and a "Zone Alarm" message will be sent to the central station. The keypad will display "EA (EXIT ALARM)," and the alarm sounding will continue until the system is disarmed (or timeout occurs).</p> <p>If Contact ID® format has been programmed, the message will contain the zone number and error code 374 (Alarm-Exit Error).</p> <p>Note: The control validates the data entered in this field. If the selection is not valid the control will emit a single long beep indicating that the selection has been rejected. The control replaces the selection with the default value "1", which is displayed on the keypad, and advances to the next field.</p>																																				

SYSTEM STATUS AND RESTORE REPORT CODES PROGRAMMING (*60-*69, *70-*76, *89)

Program Report Codes using the interactive *56 Enhanced Zone Programming Mode, or enter codes in data fields *60-*69, *70-*76, *89. Use the following guidelines when programming report codes. The actual report code digits entered depend upon the particular installation, and should be in agreement with you and the central station office receiving the signals.

With a 3+1 or 4+1 Standard Format: Enter a code in the first box: 1-9, A, B, C, D, E, or F. Enter "#+10" for A (reports a "0" on some receivers), "#+11" for B, "#+12" for C, "#+13" for D, "#+14" for E, "#+15" for F. Entering "0" in the *first* box will disable a report. Entering "0" in the second box results in automatic advance to the next field.

With an Expanded or 4+2 Format: Enter codes in *both* boxes (1st and 2nd digits) for 1-9, or A-F, as described above. Entering "0" in the first box disables a report. Entering "0" in the second box eliminates the expanded message for that report.

With ADEMCO Contact ID® Reporting: Enter a digit in the first box to enable the zone to report. Use a different digit for each zone until you have used up available digits. If the number of zones exceeds the number of available digits, begin with digit 1 again. This is an "enabling" code only and is not the actual code sent to the central station office. Entries in the second boxes will be ignored. For system status (non-alarm) codes, enter a "1" in the first box for all the system conditions you want to send to the central station. A "0" in the first box disables the report.

Data Field Descriptions

SYSTEM STATUS REPORT CODES (*60–*69)

*60	Trouble Report Code (See notes above)	This will be sent if a zone goes into trouble.
*61	Bypass Report Code (See notes above)	This will be sent when a zone is manually bypassed.
*62	AC Loss Report Code (See notes above)	Timing of this report is random with up to a 4-hour delay. If AC restores before the report goes out, there is no AC restore report.
*63	Low Battery Report Code (See notes above)	This will be sent when a low battery condition exists in the system's standby battery.
*64	Test Report Code (See notes above)	This is sent periodically to test that the communicator and phone lines are operational (frequency of report is selected in field *51). Note: The control validates the data entered in this field. If the selection is not valid the control will emit a single long beep indicating that the selection has been rejected. The control replaces the selection with the default value "10", which is displayed on the keypad, and advances to the next field.
*65	Open Report Code (See notes above)	This is sent upon disarming of the system. 2nd digit = user number, if expanded or 4+2 reporting is selected.
*66	Arm AWAY/STAY Report Code (See notes above)	This option allows for independent programming of AWAY and STAY reports. 2nd digit of report is user number if expanded or 4+2 reporting is selected. Note: OPEN reports are not sent if the associated closing report is not enabled.
*67	RF transmitter Low Batt. Report Code (See notes above)	This is sent in the event that a wireless transmitter low battery condition exists.
*68	Cancel Report Code (Always enabled, a report code can be entered if reporting formats other than Contact ID ® are used)	This is sent upon disarming of the system after an alarm condition was reported. Note: The control validates the data entered in this field. If the selection is not valid the control will emit a single long beep indicating that the selection has been rejected. The control replaces the selection with the default value "10", which is displayed on the keypad, and advances to the next field.
*69	Recent Closing Report (This feature is always enabled. A report code can be entered if formats other than Contact ID ® are used)	Sent when an alarm occurs within two minutes after exit delay expires. Disarming the system within the two minutes stops the alarm sound and the keypad displays the faulted zone number (and will display "CA" if cancel display option in field *57 is enabled.) No messages are sent to the Central Station. If the system is not disarmed within two minutes, the alarm sound continues and a "Recent Closing" and a "Zone Alarm" message are sent to the Central Station (after dial delay expires). Note: The control validates the data entered in this field. If the selection is not valid the control will emit a single long beep indicating that the selection has been rejected. The control replaces the selection with the default value "1", which is displayed on the keypad, and advances to the next field.

RESTORE REPORT CODES (*70–*76)

*70	Alarm Restore Report Code, 1st Digit (See notes above)	Sent when the zone that caused an alarm is restored to its non-faulted condition. 2nd digit is automatically sent as the 2nd digit of the zone alarm report code programmed in field *56, if expanded or 4+2 reporting is selected.
*71	Trouble Restore Report Code (See notes above)	Sent when a trouble in a zone is restored.
*72	Bypass Restore Report Code (See notes above)	Sent when a zone that has been bypassed is unbypassed.
*73	AC Restore Report Code (See notes above)	Sent when AC power has been restored after an AC power outage.
*74	Low Battery Restore Report Code (See notes above)	Sent when a system low battery condition is restored to normal.

Data Field Descriptions

*75	RF Transmitter Low Batt. Restore Code (See notes above)	Sent when a transmitter that previously sent in a “low battery” message has sent a message indicating it no longer has a low battery condition.
*76	Test Restore Report Code (See notes above)	Sent when the test mode is exited. A restore code entered here will cause a restore message to be sent when Test mode is exited. Note: The control validates the data entered in this field. If the selection is not valid the control will emit a single long beep indicating that the selection has been rejected. The control replaces the selection with the default value “10”, which is displayed on the keypad, and advances to the next field.
*87	AUX Function/1-Button Paging 0 = Aux key performs defined function (macro) 1 = Aux key sends predefined message to pager or a voice message to Follow Me system phone number	If “0” is entered, user can define a macro function for the AUX key. See user manual for description of the use of this key. If “1” is entered, you must also select an option in field *49. The options are 6-9 for the pager or 10-13 for the follow me system announcement. The actual pager message is 999-9999. Note that the hyphen may not be displayed, depending on the pager service. The manual follow me system announcement is a repeatable “System, System.....”. Note: A macro cannot be run from the Test mode.
88	Pager Characters Enter up to 16 digits that will appear in front of the 7-digit pager message. Enter [#] + [11] for “” Enter [#] + [12] for “#” Enter [#] + [13] for 2-second pause Note: Verify that the pager supports [*] and [#] characters before using them. Some pagers require an additional delay [pause] in order to receive the entire message.	If entered, these digits will appear in front of the 7-digit pager message sent by the control (either upon a system event or upon pressing the AUX key [if programmed for paging]), and during latch key report (if enabled during scheduling). These digits can consist of a PIN number, account number, pauses or special digits needed by the pager (these types of characters are not displayed), or any other characters the user chooses that will be displayed (eg., using a character code to distinguish between control panel messages and other pager messages). You do not need to fill all 16 digits. Press [*] + next field number to exit the field. To clear the field, press *88*. See field *87 to select the AUX key Paging feature. See field *49, which must have an option 6-9 selected to enable paging messages, for description of the pager message.
*89	Event Log 80% Full Report Code (See notes above)	If an Event Logging selection is made in field *90, a message can be sent to the central station receiver when the log is 80% full. If the log becomes full, a new message will overwrite the oldest message in the log. Note: All control and readout from the log, aside from the selection made by the installer in field *90, is accomplished via the downloader.
*90	Event Logging Options 0 = No event logging 1 = log Alarm/Alarm Restore 2 = log Trouble/Trouble Restore 4 = log Bypass/Bypass Restore 8 = log Open/Close x = log combination of events (add value of entries)	Example: To select “Alarm/Alarm Restore” and “Open/Close,” enter 9 (1 + 8); to select all events, enter #15. Default “3” = alarm/alarm restore (1) plus trouble/trouble restore (2). The system has the ability to record various events in a history log (84-event capacity). The types of events to be logged can be selected as indicated. At any time, the downloader operator can then upload the log and view or print out all or selected categories of the log. The log can also be cleared by the download operator. The display/printout at the central station will show the date, time, event, and description of the occurrences. Note: System messages are logged when any non-zero selection is made.
*91	Alarm Audio Verification (AAV)/Remote Phone Control 0 = none 1 = AAV and remote phone control 2 = remote phone control only 4 = AAV only Notes: (1) For UL installations alarm audio verification cannot be used. Alarm Audio Verification will only function when Contact ID® is selected. (2) AAV and Remote Phone Control features can only be used if the central station or remote phone supports DTMF commands.	This option is used to enable the Audio Alarm Verification and/or the Remote Phone Control features. Notes: (1) In order to activate the Remote Phone Control feature and defeat an answering machine, ensure that the correct ring detection count (“15”) has been programmed in field *95. (2) Remote phone session will be terminated if a report must be sent. (3) Alarm Audio Verification will only function when Contact ID® is selected. AAV cannot be used for UL installations. (4) If an alarm will be reported to primary and secondary phone numbers, AAV can only function via the secondary number. (5) If an alarm will be reported to a pager (6-8 in field *49), or to follow me phone number (10-12 in field *49) AAV cannot be used.

Data Field Descriptions

<p>*92</p>	<p>Swinger Shutdown 1 = shutdown after one alarm 2 = shutdown after two alarms</p>	<p>This option is used to define number of alarm reports sent for non-fire zones, after which the control ignores subsequent alarms of the zone during the same armed period. The zone swinger counter is reset after the zone alarm is erased from alarm memory (after two CODE + OFF).</p> <p>Note: The control validates the data entered in this field. If the selection is not valid the control will emit a single long beep indicating that the selection has been rejected. The control replaces the selection with the default value "1", which is displayed on the keypad, and advances to the next field.</p>
<p>*93</p>	<p>Flexible Callback 0 = no flexible callback 1 = last digit flexible 2 = last 2 digits flexible 3 = last 3 digits flexible</p>	<p>If enabled, the control will ignore the last 1, 2, or 3 digits of the programmed callback number (field *94) during a single download session. This allows the download operator to temporarily change the callback phone number by the number of digits selected, which allows the control to call back similar, but different numbers during a single session. For example, if downloading to a large number of controls, the operator can command the controls to call back phone numbers 555-1111, 555-1112, 555-1113, etc., thus spreading the communications among several computers.</p>

DOWNLOAD INFORMATION (*94, *95)

<p>*94</p>	<p>Download Call Back Phone Number Enter up to 20 digits as follows: 0-9, # +11 for "*", # +12 for "#", # +13 for a pause.</p>	<p>This is the phone number the control will use to call back the downloading computer. Do not fill unused spaces. End field by pressing *. To clear entries from field, press *94*.</p>
<p>*95</p>	<p>Ring Detection Count For Downloading/ Remote Phone Control 0 = disable station initiated download and remote phone 1-14 = number of rings before control picks up phone line 15 = defeat answering machine</p>	<p>Enter "15" to select defeat answering machine mode. If an answering machine is on the premises, you need to dial the premises and hang up on the first ring. Wait at least five (5) seconds (but no more than 22 seconds) and dial the premises phone number again. The control will pick up and announce "SYSTEM ENTER CODE" every three seconds.</p> <p>Note: To enter a number higher than 9 you must first press the [#] key.</p>

Data Field Descriptions

Other Programming Commands

- *56 ENHANCED ZONE PROGRAMMING MODE**
Interactive menu mode used for programming zone attributes and report codes. Refer to the **56 Enhanced Zone Programming Mode* section for procedure.
- *80 DEVICE PROGRAMMING MENU MODE**
Interactive menu mode for programming Powerline Carrier Devices. Refer to the **80 Device Programming Menu Mode* section for detailed procedure.
- *81 ZONE LISTS MENU MODE**
Interactive menu mode for programming zone lists for Powerline Carrier Devices. Refer to the **81 Zone List Menu Mode* section for detailed procedure.
- *83 ENHANCED SEQUENTIAL MODE**
Interactive menu mode used to enter RF transmitter serial numbers. Refer to the **83 Enhanced Sequential Mode* section for detailed procedure.
- *84 ASSIGN ZONE VOICE DESCRIPTORS**
Interactive menu mode used to assign descriptors to each zone. These descriptors will be announced whenever the system announces an event involving a zone.
- *85 RECORD CUSTOM VOICE DESCRIPTORS**
Interactive menu mode used to record custom descriptors for use with each zone.
- *96 INITIALIZE DOWNLOAD ID AND SUBSCRIBER ACCT. NO. FOR DOWNLOADING**
Pressing *96 initializes the system for downloading.
- *97 SET ALL PROGRAM FIELDS TO 1 OF 4 SETS OF DEFAULT VALUES**
See Default Tables at the end of this manual.
- *98 EXITS PROGRAMMING MODE**
Prevents re-entry by: Installer Code + 8 + 0 + 0; allows re-entry only by Power-up, then [*] and [#].
- *99 EXITS PROGRAMMING MODE**
Allows re-entry to program mode by: Installer Code + 8 + 0 + 0; or by Power-up, then [*] and [#].

*56 Enhanced Zone Programming Mode

This is an interactive menu mode that is used to program zone numbers, zone types, alarm and report codes, and to identify the type of loop input device. This mode can also be used for entering 5800 Series transmitter serial numbers.

Note: There are two methods for entering transmitter serial numbers. The first method is by using *56 Enhanced Zone Programming mode (described below). The second method is by using *83 Enhanced Sequential Mode. Note that the *83 Enhanced Sequential Mode requires that all zone information first be entered using *56 Enhanced Zone Programming mode.

You must refer to these instructions or to the Program Form while programming the system because the keypad display does not show prompt titles. Instead, prompts are indicated by a number/letter combination. The prompts for *56 are as follows:

- Zone Number----- for entering the zone number
- Zone Type ----- for entering zone type
- Report Code----- for entering the zone's report code
- Input Type ----- for entering the transmitter's input type
- Loop Number----- for entering the transmitter loop number
- Delete Serial Number? ----- for deleting existing serial number
- Enroll Mode? ----- selects serial number enroll mode
- Serial Number ----- for entering transmitter's serial number
- Voice Descriptor?----- selects voice descriptor mode
- Descriptor 1----- for entering first descriptor word
- Descriptor 2----- for entering second descriptor word
- Descriptor 3----- for entering third descriptor word

*56 Enhanced Zone Programming Mode

While in Program mode, press *56 to enter Zone Programming Menu Mode.

Refer to the zone assignment table for *56 on the separate programming form.

The following explains the *56 prompts in detail. The left two columns identify the prompts and list the available entries for each. The right-most column provides a further explanation of the entries.

Note: You may find it convenient to adjust the volume setting before entering the Programming Mode. This will allow you to clearly hear feedback announcements or system beeps.

<div style="border: 1px solid black; padding: 5px; text-align: center;"> R 01 </div>	<p>Zone number 01-41, 95, 96, 99 = Zone number [*] = continue 00 = exit Zone Programming mode</p>	<p>Enter the 2-digit zone number to be programmed and the Voice Descriptor for the selected zone number will be announced, if it is programmed. Press [*] to advance.</p> <ul style="list-style-type: none"> • Zone 01 = hardwire • Zones 02-25 = RF zones (only) • Zones 26-41 = Button zones (only) • Zone 92 = Duress • Zones 95, 96, 99 = Panic zones <p>Pressing 00 exits mode, upon which the prompt "56" blinks, indicating the mode is inactive. Press [*] + any field number to go to that field.</p>																		
<div style="border: 1px solid black; padding: 5px; text-align: center;"> b zt </div>	<p>Zone type 00-24 = zone type [*] = continue [#] = return to previous prompt</p> <p>Note: If 00 is accepted as a zone type, save the 00 zone type and advance to the confirm delete prompt (F).</p>	<p>Each zone must be assigned to a zone type, which defines the way in which the system responds to faults in that zone. Enter the 2-digit zone type for this zone as follows:</p> <table style="width: 100%; border: none;"> <tr> <td style="width: 50%;">00 = Not Used</td> <td style="width: 50%;">09 = Fire without verification</td> </tr> <tr> <td>01 = Entry/Exit #1</td> <td>10 = Interior w/Delay</td> </tr> <tr> <td>02 = Entry/Exit #2</td> <td>16 = Fire with verification</td> </tr> <tr> <td>03 = Perimeter</td> <td>20 = Arm-Stay</td> </tr> <tr> <td>04 = Interior Follower</td> <td>21 = Arm-Away</td> </tr> <tr> <td>05 = Trouble Day/Alarm Night</td> <td>22 = Disarm</td> </tr> <tr> <td>06 = 24 Hr Silent</td> <td>23 = No Alarm Response</td> </tr> <tr> <td>07 = 24 Hr Audible</td> <td>24 = Silent Burglary</td> </tr> <tr> <td>08 = 24 Hr Aux</td> <td></td> </tr> </table> <p>Notes: 1. ZT9 and ZT16 can not be assigned to Zone 01 (hard wire zone). 2. ZT16 is not for use with manually actuated devices including fire, keypad or keyfob zones, or fire pull stations, or for heat detectors.</p> <p>SIA ZT 16 must be used in SIA fire applications.</p>	00 = Not Used	09 = Fire without verification	01 = Entry/Exit #1	10 = Interior w/Delay	02 = Entry/Exit #2	16 = Fire with verification	03 = Perimeter	20 = Arm-Stay	04 = Interior Follower	21 = Arm-Away	05 = Trouble Day/Alarm Night	22 = Disarm	06 = 24 Hr Silent	23 = No Alarm Response	07 = 24 Hr Audible	24 = Silent Burglary	08 = 24 Hr Aux	
00 = Not Used	09 = Fire without verification																			
01 = Entry/Exit #1	10 = Interior w/Delay																			
02 = Entry/Exit #2	16 = Fire with verification																			
03 = Perimeter	20 = Arm-Stay																			
04 = Interior Follower	21 = Arm-Away																			
05 = Trouble Day/Alarm Night	22 = Disarm																			
06 = 24 Hr Silent	23 = No Alarm Response																			
07 = 24 Hr Audible	24 = Silent Burglary																			
08 = 24 Hr Aux																				
<div style="border: 1px solid black; padding: 5px; text-align: center;"> [rc </div>	<p>Report code Enter the report code for this zone. [*] = continue [#] = return to previous prompt</p>	<p>The report code consists of 2 hexadecimal digits, each in turn consisting of 2 numerical digits. For example, for a report code of "3C", enter [0][3] for "3" and [1][2] for "C". If this is Zone 1, 95, 96 or 99, the system skips to the VOICE DESCRIPTOR prompt (1C).</p>																		
<div style="border: 1px solid black; padding: 5px; text-align: center;"> d i </div>	<p>Input type 3 = RF (supervised RF) – sends periodic check-in signals, faults, restore and low battery signals Note: RF type transmitters must remain within range of the receiver, otherwise a supervision failure signal will occur. 4 = UR (unsupervised RF) – sends same as "RF" type, but control does not supervise the check-in signals 5 = BR (button type) – sends only fault and low battery signals; does not send restores or check-in signals Note: UR and BR type transmitters may be carried off premises (out of range without causing a supervision failure). [*] = continue [#] = return to previous prompt</p>	<p>Enter the input type for the transmitter assigned to this zone. Refer to the transmitter's instructions for input types of each transmitter.</p> <p>Note: Zones 2-25 should be assigned Input Type 3 or 4. Zones 26-41 should be assigned Input Type 5 only.</p>																		

*56 Enhanced Zone Programming Mode

<div style="border: 1px solid black; padding: 5px; width: fit-content; margin-bottom: 10px;">E /</div>	<p>Loop number or Loop and Serial number (if using RF Learning) 1-4 = loop number for the zone of the transmitter being entered. 0 + [*] = continue to DELETE ZONE PARAMETERS CONFIRMATION prompt (F) [*] = continue to the ENROLL MODE prompt (1A) if not entered, or VOICE DESCRIPTOR prompt if already entered [#] = return to previous prompt</p>	<p>This prompt can be used to enroll loop number and serial number via RF transmission or the loop number can be enrolled manually. If using the RF Learning Mode, there is no need to manually enter a loop number. Proceed directly to RF Learning</p> <p>Notes: (1) BR type devices cannot be enrolled by using UR or RF type. Likewise, UR or RF type devices cannot be enrolled by using a BR type device. There is a 52-second time-out for RF enrolling. At the end of the time-out, the system returns to the INPUT TYPE prompt (d). If enrolled, loop number and "L" are displayed. (2) Once encrypted (high-security) devices have been enrolled they must be activated. Refer to the device's Installation Instructions to activate the High-Security Mode.</p> <p>RF Learning - Two (2) transmissions (2 key depressions) at least 5 seconds apart will be required for BR type devices (device type 5). Two beeps will sound after the second transmission, confirming that the loop number and serial number have been learned.</p> <p>For all other device types, four (4) transmissions are required (fault, restore and fault, restore). A single beep will sound after the second transmission confirming that the loop and serial number have been captured. Following the fourth transmission the system will confirm that the loop number and serial number have been learned and announce the Voice Descriptor for the zone, if it is programmed, followed by two beeps. Press [*] to continue.</p> <p>Manual Entry - Enter the desired loop number and press [*] to continue (see the transmitter's Installation Instructions for specific loop designations).</p> <p>Note: The loop number can be changed even if the zone has already been entered. Care should be taken when using this feature as it has the capability to make zones inoperable by creating a mismatch of a working serial number/loop number combination. This should be re-confirmed if the loop number is changed.</p> <p>"L" indicates that the zone's serial number has already been enrolled.</p>
<div style="border: 1px solid black; padding: 5px; width: fit-content; margin-bottom: 10px;">F</div>	<p>Delete zone parameters confirmation 0 = discard the delete request 1 = confirm requested delete</p> <p>Note: If 00 was entered as a zone type in prompt (b), 00 will be retained and system will advance to prompt (1C).</p>	<p>This function deletes either the serial number or all zone information that is programmed for the zone. If "00" was entered in the zone type, the confirmation of the delete request will delete all information associated with the zone currently being programmed.</p> <p>If "0" was entered in the loop number, the confirmation of the delete request will delete the serial number of to the zone currently being programmed.</p>
<div style="border: 1px solid black; padding: 5px; width: fit-content; margin-bottom: 10px;">1A LC</div>	<p>Enroll mode 0 = advance to the VOICE DESCRIPTOR prompt (1C). Note: This will save all zone parameters. 1 = enter now and proceed to SERIAL NUMBER prompt (1b). Note: Not applicable if the serial number is already present. 2 = copy the last serial number entered into local ram. Note: If this is the 1st zone, none will be in the buffer and the panel will emit a long tone. Not valid if serial number is already present. 3 = view existing serial number. Note: Only if "L" is displayed. If "L" is not displayed, panel will emit a long beep. 9 = advance to F; delete existing serial number. Note: Only if "L" is displayed. If "L" is not displayed, panel will emit a long beep. [*] = advance to the VOICE DESCRIPTOR prompt (1C). This will save all zone parameters. [#] = return to the LOOP NUMBER prompt (E). Note: In order for all entered parameters to be accepted, you must advance to the VOICE DESCRIPTOR prompt (1C).</p>	<p>If "L" is displayed, the serial number for this transmitter has already been entered. It may, however, still be viewed, confirmed (only if in listen mode), or deleted.</p> <p>View serial number Enter "3". Each digit will be redisplayed, and the keypad will beep once for digits 1-6, and three times for the last digit.</p> <p>Confirm serial number The serial number/loop number combination can be confirmed after one transmission from a BR type device or two transmissions (fault and restore) from a UR or RF type device. If a transmission is received that matches the serial number and loop number entered, the system will confirm the reception by announcing the Voice Descriptor for the zone, if it is programmed, followed by three beeps, and a "C" will appear on the display indicating the received serial number and loop number have been confirmed. No further transmissions will be received.</p> <p>Delete serial number The serial number can be deleted by entering "9".</p> <p>If "L" is not displayed, the serial number for this transmitter has not been previously entered. You may enter the serial number manually, copy the previous serial number, return to Prompt (E) or enter the serial number later using the *83 Enhanced Sequential Mode.</p>

*56 Enhanced Zone Programming Mode

		<p>Manual entry Enter "1" to advance to Serial number prompt (1b). Copy the previous serial number Enter "2" to copy the previous serial number entered. Return to Prompt (E) Enter "#" to return to Loop Number prompt (E). Enter transmitter later Enter "0" or "*" if you wish to enter the transmitter later, using the *83 Enhanced Sequential Mode described later in this manual.</p> <p>Notes: (1) The panel will listen only when it is in the idle loop waiting for key entry and a serial number has been entered. If a key is entered, the function must be completed and the panel will listen again. (2) A long beep indicates illegal entry or duplicate serial number/loop entry</p>
1b	<p>Serial number Enter the transmitter's 7-digit serial number. [#] = return to prompt 1A and reject any serial numbers entries that have been made. [*] = return to prompt 1A, (if a valid serial number has been entered, the "L" is displayed and the serial number will be copied into EEROM from the last serial entered into the buffer.)</p> <p>Note: This prompt can be used only to manually enroll a serial number. RF enrollment will be rejected and the current zone descriptor will be announced, followed by a single long beep and the system will return to prompt (1A).</p>	<p>In this mode, the transmitter serial numbers can only be entered manually.</p> <p>Enter the 7-digit serial number printed on the transmitter. If an incorrect digit is entered, press the [#] key to backup to prompt (1A) and start over. When all 7 digits are entered, press the [*] key.</p> <p>If 52 seconds passes and no entry has been made, the system returns to prompt (1A).</p> <p>Notes: (1) If the serial and loop number combination is already present the keypad will emit a single long beep and the system will return to the (1A) prompt and "L" will be displayed. (2) If less than 7 digits have been entered, the keypad will emit a single long beep and return to the (1A) prompt without displaying the "L". (3) If more than 7 digits have been entered, the first 6 digits will be saved along with the last digit that was entered (entering 123456789 yields the serial number 1234569).</p>
1E	<p>Voice descriptor 0 = skip to next zone (A) 1 = enter descriptor mode; existing descriptor for this zone will be announced</p>	<p>Each zone can have a voice descriptor of up to 3 words that will be announced whenever the system announces status for that zone.</p>
1d vi	<p>Descriptor 1 Enter [#] + 2-digit vocabulary index number of first descriptor word for this zone. 6 = accept word and advance to descriptor 2 (descriptor 2 will be announced) 8 = accept word and advance to next zone (prompt A) – entire zone descriptor will be announced Press any other key to repeat the selected word.</p>	<p>† see *84 Assign Zone Voice Descriptors section for vocabulary index</p> <p>Use the [6] or [8] key to advance as described. To change the entered index number before pressing [6] or [8], simply press [#] + desired 2-digit vocabulary index number. If descriptor 1 is not desired, enter [#] + 99 (blank), then press [8] to return to zone number prompt.</p>
1E vi	<p>Descriptor 2 Enter [#] + 2-digit vocabulary index number of second descriptor word for this zone. 6 = accept word and advance to descriptor 3 (descriptor 3 will be announced) 8 = accept word and advance to next zone (prompt A) – entire zone descriptor will be announced Press any other key to repeat the selected word.</p>	<p>† see *84 Assign Zone Voice Descriptors section for vocabulary index</p> <p>Use the [6] or [8] key to advance as described. To change the entered index number before pressing [6] or [8], simply press [#] + desired 2-digit vocabulary index number. If descriptor 2 is not desired, enter [#] + 99 (blank), then press [8] to return to zone number prompt.</p>
1F vi	<p>Descriptor 3 Enter [#] + 2-digit vocabulary index number of third descriptor word for this zone. 6 or 8 = accept word and advance to next zone (prompt A) – entire zone descriptor will be announced Press any other key to repeat the selected word.</p>	<p>† see *84 Assign Zone Voice Descriptors section for vocabulary index</p> <p>Use the [6] or [8] key to advance as described. To change the entered index number before pressing [6] or [8], simply press [#] + desired 2-digit vocabulary index number. If descriptor 3 is not desired, enter [#] + 99 (blank), then press [8] to return to zone number prompt.</p>

*80 Device Programming Menu Mode

Powerline Carrier devices (eg., X-10 brand devices) are programmable switches that can be used to perform many different functions. They can be used to turn lights on and off, control sounders, or for status indications. In this system, each device must be programmed as to how to act (ACTION), when to activate (START), and when to deactivate (STOP). Each of these is described below.

The control supports a total of 8 output devices.

The 1332X10 transformer sends signals from the control panel through the premises AC wiring to the Powerline Carrier Devices (which are plugged into AC outlets). Devices plugged into Powerline Carrier Devices can then be made to perform various functions in response to commands entered at the keypads in the security system.



Powerline Carrier Devices are not UL Listed for fire or burglary functions and are intended for home automation.

Programming Options Defined

The following will help you understand the programming of output devices when using *80 and *81 modes.

ACTION The "ACTION" of the device is how the device will respond when it is activated by the "START" programming. There are four different choices of actions:

- ACTIVATE for 2 SECONDS and then reset.
- ACTIVATE and REMAIN ACTIVATED until stopped by some other event.
- PULSE ON and OFF until stopped by some other event.
- NOT USED when the device is not used.

START The "START" programming determines when and under what conditions the device will be activated. The following START options are available:

Start by Event

1. Event is the condition (alarm, fault, trouble) that must occur to a zone or group of zones (zone list) in order to activate the device. These conditions apply **only** when a zone list is used. The different choices for "EVENT" are listed below and in the "Programming Powerline Carrier Devices" paragraph that follows.
 - ALARM Device activates upon any alarm in an assigned zone in the zone list.
 - FAULT Device activates upon any opening or short in an assigned zone in the zone list.
 - TROUBLE Device activates upon any trouble condition in an assigned zone in the zone list.
 - NOT USED Device action is not dependent upon one of the above events.
2. A zone list is a group of zones to which the "EVENT" applies in order to activate a particular device. Note that there are a total of 3 output device-related zone lists that can be programmed in *81 menu mode; when the selected EVENT (alarm, fault or trouble) occurs in **any** zone in the selected "Start" ZONE LIST (1, 2, or 3), activation of the selected device will START.

Start by Zone Type or System Operation

- If a system operation, such as "DISARMING" or "ANY FIRE ALARM," is to activate the device, the appropriate choice would also be entered under the "ZONE TYPE" option. "ZONE TYPE" is used independently of the "EVENT/ZONE LIST" combination.
- If a "ZONE TYPE" is chosen, any zone of that response type going into alarm, trouble, or fault will cause the device to activate as selected in "ACTION." If the same "ZONE TYPE" is also chosen for the STOP programming, any zone of that type that restores will de-activate the device.
- If a "SYSTEM OPERATION" is chosen (e.g., End of Exit Time), that operation will cause the device to activate as selected in "ACTION." The different choices for "ZONE TYPE" and "SYSTEM OPERATION" are listed in the "Start zone type" paragraphs later in this section, and in the Programming Form.

*80 Device Programming Menu Mode

STOP The "STOP" programming determines when and under what conditions the device will be de-activated. The following options are available:

Upon Restore of a Zone List

Restore Zone List: If a "ZONE LIST" is used as the "Stop" event, the device will de-activate when **all** the zones in that list restore from a previous fault, trouble, or alarm condition. This will occur regardless of what is programmed to "START" the device; therefore, a "RESTORE ZONE LIST" would normally only be used when a "ZONE LIST" is used to start the device.

Upon a Zone Type or System Operation

Zone Type/System Operation: Instead of using a "RESTORE ZONE LIST," a specific zone (response) type or system operation action can be selected to de-activate the device.

- If a specific "ZONE TYPE" is chosen, any zone of that response type that restores from a previous alarm, trouble, or fault condition will cause the device to de-activate.
- If a "SYSTEM OPERATION" is chosen, that operation will cause the device to de-activate.

During normal system operation, any devices may be manually started by keypad entry of: **Code* + [#] + 4 + "n;"** or manually stopped by keypad entry of: **Code* + [#] + 7 + "n,"** where "n" = the device number to be controlled.

* Code is required for devices 7 and 8. For devices 1-6, code is not required. See User Manual for more information.

Programming Powerline Carrier Devices

While in program mode, press *80 to enter Output Device Menu Mode. This mode is used to program all output devices used in the system. Refer to the output device table for *80 on the separate programming form when programming output devices.

Note: The House ID of the Powerline Carrier Devices must be entered in data field *25.

The prompts for *80 are as follows:

80	Powerline Carrier Device Programming Main Menu prompt
A 01	Device Number-----for entering the device number
b	Device Action -----for defining the action the device will perform when active
C	Start Event Type -----for assigning the event type to start the action
d	Start Zone List -----for assigning the zone list to start the action
E	Start Zone Type -----for assigning the zone type to start the action
F	Stop Zone List -----for assigning the zone list to stop the action
1A	Stop Zone Type-----for assigning the zone type to stop the action

*80 Device Programming Menu Mode

The following explains these prompts in detail. The left two columns identify the prompts and list the available entries. The right-most column provides a further explanation of the entries.

Note: Entering a number other than one specified will give unpredictable results.

<p style="text-align: center; font-size: 24pt;">80</p>	<p>Powerline Carrier Device programming 0 = exit mode 1 = enter mode</p>	<p>Entering "1" advances to the next prompt below. Entering "0" exits mode, upon which this prompt blinks, indicating the mode is inactive.</p>																												
<p style="text-align: center; font-size: 24pt;">A 01</p>	<p>Device number 01-08 = device number to be programmed [*:] = continue 00 = exit Device Programming mode</p>	<p>Enter device numbers as 2-digit entries.</p>																												
<p style="text-align: center; font-size: 24pt;">b aa</p>	<p>Device action 0 = No response 1 = Close for 2 seconds 2 = Close and Stay Closed 3 = Continuous Pulse on & off (1 sec ON, 1 sec OFF) [*:] = continue [#] = return to previous prompt</p>	<p>Enter the 1-digit action (0-3) for the device being programmed (current action is displayed). NOTES: 1. If "3" is entered (pulse), only up to 3 different devices can be pulsed if one of the devices is a siren/horn (X-10 Powerhouse Security model SH10A). In addition, the siren/horn cannot be manually activated using the lights on/lights off keypad commands. 2. If using an X-10 Powerhouse Security SH10A siren: • you must use device action "3." • you must change the device action default to "3" if using default table 2 or 4</p>																												
<p style="text-align: center; font-size: 24pt;">[et</p>	<p>Start event type 0 = Not used 3 = Trouble 1 = Alarm [*:] = continue 2 = Fault [#] = return to previous prompt</p>	<p>Enter the 1-digit event type (0-3) to activate the device being programmed. A zone list must be used in conjunction with an event. If a zone type/system operation is to be used instead of an event, enter "0".</p>																												
<p style="text-align: center; font-size: 24pt;">d zl</p>	<p>Start zone list 1-3 = zone list number (to be programmed in field *81) 0 = zone list not used for this device [*:] = continue [#] = return to previous prompt</p>	<p>If a zone list will be used to start the device action, enter the zone list number at this prompt.</p>																												
<p style="text-align: center; font-size: 24pt;">E zt</p>	<p>Start zone type 01-58 = zone type to start this device action (select only those that are applicable) 00 = zone type not used for this device [*:] = continue [#] = return to previous prompt</p>	<p>If a zone type or system operation will be used to start the device action, enter the appropriate 2-digit code for the device being programmed (see table that follows).</p> <p style="text-align: center;">Choices for zone types</p> <table style="width: 100%; border: none;"> <tr> <td>00 = Not Used</td> <td>07 = 24 Hr Audible</td> </tr> <tr> <td>01 = Entry/Exit #1</td> <td>08 = 24 Hr Aux</td> </tr> <tr> <td>02 = Entry/Exit #2</td> <td>09 = Fire without verification</td> </tr> <tr> <td>03 = Perimeter</td> <td>10 = Interior w/Delay</td> </tr> <tr> <td>04 = Interior Follower</td> <td>16 = Fire with verification</td> </tr> <tr> <td>05 = Trouble Day/Alarm Night</td> <td>24 = Silent Burglary</td> </tr> <tr> <td>06 = 24 Hr Silent</td> <td></td> </tr> </table> <p style="text-align: center;">Choices for system operation</p> <table border="1" style="width: 100%; border-collapse: collapse;"> <tr> <td>20 = Arming-Stay</td> <td>38 = Chime</td> </tr> <tr> <td>21 = Arming-Away</td> <td>52 = Kissoff</td> </tr> <tr> <td>22 = Disarm. (Code + OFF)</td> <td>39 = Any Fire Alarm</td> </tr> <tr> <td>31 = End of Exit Time</td> <td>40 = Bypassing</td> </tr> <tr> <td>32 = Start of Entry Time</td> <td>42 = System Battery Low</td> </tr> <tr> <td>33 = Any Alarm (except zt 08 or 09)</td> <td>43 = Communications Failure</td> </tr> <tr> <td>36 = At Bell Timeout**</td> <td>58 = Duress</td> </tr> </table> <p>** Or at Disarming (which ever occurs earlier) SIA Zt 16 must be used in SIA fire applications.</p>	00 = Not Used	07 = 24 Hr Audible	01 = Entry/Exit #1	08 = 24 Hr Aux	02 = Entry/Exit #2	09 = Fire without verification	03 = Perimeter	10 = Interior w/Delay	04 = Interior Follower	16 = Fire with verification	05 = Trouble Day/Alarm Night	24 = Silent Burglary	06 = 24 Hr Silent		20 = Arming-Stay	38 = Chime	21 = Arming-Away	52 = Kissoff	22 = Disarm. (Code + OFF)	39 = Any Fire Alarm	31 = End of Exit Time	40 = Bypassing	32 = Start of Entry Time	42 = System Battery Low	33 = Any Alarm (except zt 08 or 09)	43 = Communications Failure	36 = At Bell Timeout**	58 = Duress
00 = Not Used	07 = 24 Hr Audible																													
01 = Entry/Exit #1	08 = 24 Hr Aux																													
02 = Entry/Exit #2	09 = Fire without verification																													
03 = Perimeter	10 = Interior w/Delay																													
04 = Interior Follower	16 = Fire with verification																													
05 = Trouble Day/Alarm Night	24 = Silent Burglary																													
06 = 24 Hr Silent																														
20 = Arming-Stay	38 = Chime																													
21 = Arming-Away	52 = Kissoff																													
22 = Disarm. (Code + OFF)	39 = Any Fire Alarm																													
31 = End of Exit Time	40 = Bypassing																													
32 = Start of Entry Time	42 = System Battery Low																													
33 = Any Alarm (except zt 08 or 09)	43 = Communications Failure																													
36 = At Bell Timeout**	58 = Duress																													
<p style="text-align: center; font-size: 24pt;">F zl</p>	<p>Stop zone list 1-3 = zone list to stop this device action 0 = zone list not used [*:] = continue [#] = return to previous prompt</p>	<p>If a zone list will be used to STOP, or restore, the device action, enter the zone list number 1, 2, or 3 (to be programmed in *81 mode). If not used, enter "0".</p>																												
<p style="text-align: center; font-size: 24pt;">IR zt</p>	<p>Stop zone type 01-58 = zone type to start this device action (select only those that are applicable) 00 = zone type not used for this device [*:] = continue [#] = return to previous prompt</p>	<p>If a zone type or system operation will be used to STOP the device action, enter the appropriate 2-digit code (see the "ZT" choices listed above). If not, enter 00. The display then returns to the DEVICE NUMBER prompt (A) so that you can enter the next device number to be programmed, or enter [0][0] to end device programming.</p>																												

*81 Zone List Menu Mode

While in Program mode, press *81 to enter Zone List Menu Mode. This mode is used to program zone lists for output devices (programmed in *80 menu mode) or Chime-by-Zone in Zone List 3.

NOTES:

- Any list may include any or all of the systems zone numbers.
- A zone list can be assigned to more than one Powerline Carrier Device.

The prompts for *81 are as follows:

81	Zone List Programming ----- Main Menu prompt
A 01	Zone List Number----- for entering the zone list number to be programmed
b	Zone Entry to List----- for entering zones to the assigned zone list
C	Delete Entire List?----- for deleting the entire zone list and its contents
d	Delete Specific Zones From List? -- Selects to delete zones or return to next zone list number
E	Delete Zones ----- for deleting specific zones from the current zone list

The following explains these prompts in detail. The left two columns identify the prompts and list the available entries. The right-most column provides a further explanation of the entries.

- Notes:**
- (1) Entering a number other than one specified will give unpredictable results.
 - (2) Do not assign zones with zone types 20, 21 or 22 to a zone list.
 - (3) Zone List 2 should be used for Cross Zoning. When creating zone list 2 for cross zoning, include only 2 zones assigned to zone types 3, 4, or 5. If interior zones (zone type 4) are cross zoned, then both zones in zone list 2 must be interior zones. Do not cross zone more than 2 zones, or zone types that have delays (entry/exit zones, interior w/delay), or 24-hour zones, as these choices may produce unpredictable operation and may not function as intended. If cross zoning is used, zone list 2 should not be used for other purposes, such as triggering powerline carrier devices. If field *39 has been set to "0" (no cross zoning), then Zone List 2 can be used for other purposes.

81	<p>Zone list programming 0 = exit mode 1 = enter mode</p>	<p>Pressing 1 advances to the next prompt below. Pressing 0 exits mode, upon which this prompt blinks, indicating the mode is inactive.</p>
A 01	<p>Zone list number 01-03 = zone list number to be programmed 00 = exit Zone List mode [*] = continue</p>	<p>Enter the Zone List Number 01, 02, or 03 to program (or 00 if no zone lists are used).</p>
b zz	<p>Zone entry to list 01-41, 95, 96, 99 = zone numbers to add to zone list [*] = accept zone number and enter the next zone number 00 = accept zone number(s) and continue to next prompt</p>	<p>Enter each zone number to add to the zone list by first entering the zone number, then the [*] key (for example, 01* 02* 03*). The system will announce the Voice Descriptor for the selected zone, if it is programmed. After all desired zones are enrolled, enter "00" to advance.</p>
C	<p>Delete entire zone list? 0 = don't delete; continue to next prompt 1 = delete the current zone list</p>	<p>To delete the zone list, enter "1". All zones in the zone list will be deleted automatically and programming will return to the ZONE LIST NUMBER prompt. To save the zone list or delete specific zones from the list, enter "0".</p>
d	<p>Delete zones from list? 1 = continue to delete zones prompt 0 = don't delete; continue to next zone list number prompt (A...01) [#] = return to zone list number prompt (A...01)</p>	<p>To save the entire zone list, enter "0" and programming will return to the ZONE LIST NUMBER prompt. To delete a zone or zones in a zone list enter "1".</p>
E	<p>Delete zones Enter each 2-digit zone number to be deleted from the current zone list, followed by the [*] key. [*] = delete zone and enter next zone to be deleted 00 = delete zone and return to next zone list number prompt (A...01) desired</p>	<p>When deleting a zone(s) from the zone list, if the selected zone has a Voice Descriptor programmed, upon deletion it will be announced as a confirmation that it has been deleted. After all zones to be deleted are entered, enter "00" to return to the ZONE LIST NUMBER prompt so that another list can be programmed, if desired.</p>

*83 Enhanced Sequential Mode

By using this mode, you can add, delete, or change the serial number of a transmitter in a zone, but retain all other existing data that has been programmed for that zone. Note that the *83 Enhanced Sequential mode requires that all zone information must first be entered using the *56 Enhanced Zone Programming mode for all zones below zone number 26 (4 button key area).

Note: Any zone which already has a serial number learned in will not be accessible in *83 Enhanced Sequential mode!

Certain button-type transmitters have more than one button (e.g., 5804). Note that each button must be assigned to a different zone. Similarly, the 5816 Transmitter has contact terminals *and* a reed switch for use with a magnet. If using both, each must also be assigned to a different zone.

This means that the procedures that follow must be repeated for each button-type zone below zone number 26 or contact on the transmitter. Four zone button-type devices are held in zones 26 and above. They will be started on boundaries of zones 26, 30, 34, and 38. These four zone button-type devices will have the option to have all information entered in this field. One entry will set the loop number, report code, zone type, and input device type for all 4 buttons, and a second entry will enter one serial number into four zones.

Note: Use this mode only after all other zone information has been programmed, including transmitter loop numbers except for button-type zones over zone number 26. The panel will stop at zones 26, 30, 34 and 38 and zone data can be entered as a default here.

Enter Serial Number Sequential mode by pressing *83. The prompts for *83 are as follows:

A 01	Zone Number-----for entering the zone number to be programmed
1A	Enroll Mode-----Selects method of serial number or viewing
1b	Enroll Serial Number-----for entering transmitter serial numbers
F	Delete Serial Number -----for deleting existing serial numbers

The following explains these prompts in detail. The left two columns identify the prompts and list the available entries. The right-most column provides a further explanation of the entries.

- Notes:**
- (1) Entry of a number other than one specified will give unpredictable results.
 - (2) In Enhanced Sequential Mode, 4 button type keys will always be enrolled simultaneously. They will be stopped at the 4 button boundaries of 26, 30, 34 and 38, provided the zone is free of a serial number. If the first zone of the key has a serial number enrolled, the remaining keys cannot be programmed in sequential mode. In addition, if the zone has not been set up (duplicate loop, missing zone type, etc.) only entries 0 (skip to the next zone) and 4 (copy the key template) will be allowed.
 - (3) You may find it convenient to adjust the volume setting before entering the Programming Mode. This will allow you to clearly hear feedback announcements or system beeps.

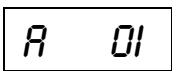
	<p>Zone number Enter the 2-digit zone number. [*:] = continue; system searches for zones not yet entered (for zones 2 through 25 a zone type must be entered), then advances to ENROLL SERIAL NUMBER prompt "1b" 00 = exit Sequential mode</p>	<p>Enter the 2-digit zone number of the first transmitter to have its serial number entered. The system will announce the Voice Descriptor for the selected zone number, if it is programmed.</p> <p>Press [*:] to continue. Starting with this zone number, the system will search for the first transmitter that has all of the following attributes pre-programmed in *56 ENHANCED ZONE PROGRAMMING:</p> <ol style="list-style-type: none"> Make sure that the appropriate input type was selected in *56 (RF, UR, or BR programmed) Make sure that the appropriate loop number was selected in *56. No serial number programmed Zone type <p>If the first zone number entered does not have one or more of the above attributes, the system will search its database for the first zone that does, and will display it at the enroll SERIAL NUMBER prompt (1b). Pressing 00 exits mode, upon which the prompt "83" blinks, indicating the mode is inactive.</p> <p>Note: Two exceptions to the requirement above exist for keys. Four zone button type devices (zone numbers 26, 30, 34, and 38) will be stopped only if there are no serial numbers enrolled in all 4 zones of the key, regardless of the attributes that have been entered. In addition, zone types are not required to be present. In this case, 1A, Option 4 must be selected prior to "Learn".</p>
--	---	--

*83 Enhanced Sequential Mode

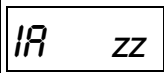
	<p>Enroll mode</p> <p>0 = advance to next zone to be enrolled 1 = enter now and proceed to SERIAL NUMBER prompt (1b). For 4 button keys (zones 26-29, 30-33, 34-37, & 38-41) the serial number will be enrolled to all four buttons.</p> <p>If enrolling a key, the panel will emit a long beep when entering a 1 to indicate that the present key set up is invalid.</p> <p>Notes:(1) A valid template or key has 4 existing zones, each with a zone type, unique loop number. (2) If the display automatically advances to "1A" rather than "1b" the configuration of the key is not valid. At that point copy template, skip, or return are the only legal entries.</p> <p>2 = copy the previous serial number entry from the buffer.</p> <p>Notes:(1) Before you can copy a serial number you must first enter a serial number. If no serial is stored in the buffer and a copy is attempted the panel will emit a long beep indicating an invalid operation. (2) Not applicable for 4 button key zones 26-29, 30-33, 34-37, & 38-41.</p> <p>3 = view existing serial number.</p> <p>Note: Only if "L" is displayed. If the "L" is not displayed the panel will emit a long beep.</p> <p>4 = copy the 4 button key template that has been set in zone numbers 26-29 (all zone parameters except serial numbers). (Only valid on zones 30-33, 34-37, & 38-41 that do not have serial numbers enrolled.)</p> <p>Notes:(1) Template acceptance is indicated by two beeps after copying. (2) A single long beep emitted when copying a indicates the template is not valid.</p> <p>9 = delete existing serial. Go to the (1A) prompt. For 4-button key, zones 26-29, 30-33, 34-37, & 38-41 have serial numbers. Delete all four at one time.</p> <p>Note: Only if "L" is displayed. If the "L" is not displayed the panel will emit a long beep.</p> <p>[*] = advance to next zone to be enrolled [#] = return to previous prompt (A)</p>	<p>Note: If "L" is displayed, the serial number for this transmitter has already been entered, however, it may still be confirmed, viewed or deleted.</p> <p>If the transmitter's serial number has not been previously entered, you may enter the enroll serial number mode (1A) by entering "1", or copy the last serial number that was entered by entering "2".</p> <p>If the transmitter's serial number has been previously entered, you may, view the present serial number by entering "3". If view is selected each digit will be re-displayed, and the keypad will beep once for digits 1-6, and three times for the last digit. Once the serial number has been entered by either selecting a "1" or a "2", you will return to this prompt with the "L" on the display. The serial number/loop number combination that was entered can be confirmed by getting two transmissions (fault and restore) from the RF or UR device or one transmission from the BR device. If a transmission is received that matches the serial number and loop number entered, the system will announce the Voice Descriptor for the loop followed by three beeps, and a "C" will be displayed indicating that the received serial number and loop number transmission has been confirmed to match. No further transmissions will be received. When confirming a 4 button key, only the serial number is confirmed, since it assumed that all loops are used. Pressing any key will allow a confirmation.</p> <p>*Long beep indicates illegal entries, or duplicate serial number/loop entry*</p> <p>When the last zone has been entered, the display will remain on that zone. To exit this mode and return to data field program mode, press 00 at the ZONE NUMBER prompt.</p> <p>When all zones have been programmed, test each zone using the system's Test mode. Do not use the Transmitter ID Sniffer mode for this, since it will only check for transmission of one zone on a particular transmitter, and not the zones assigned to each additional loop.</p> <p>For Zones 26-29, 30-33, 34-37, and 38-41 any loop can be used for RF enrollment. If enrolling via RF, it will be confirmed without additional transmissions.</p>
---	---	--

*83 Enhanced Sequential Mode

<div style="border: 1px solid black; padding: 5px; margin-bottom: 10px;">lb zz</div> <div style="border: 1px solid black; padding: 5px;">lb</div>	<p>Serial number</p> <p>Enter transmitter's 7- digit serial number via RF learning or manually.</p> <p>[#] = return to (1A) prompt and reject whatever serial number entries have been made.</p> <p>[*:] = return to (1A) prompt (if a valid serial number has been enrolled, "L" is displayed and the serial number will be copied into EEROM and the last serial entered buffer.</p> <p>Note: For zones 26, 30, 34 and 38 only BR type devices can be used.</p>	<p>This prompt can be used to enroll the transmitter serial number via RF transmission or manually. If using the RF Learning Mode there is no need to manually enter a serial number. Proceed directly to RF Learning. Upon entering the Serial Number mode, the Zone Descriptors will be announced.</p> <p>Note: BR type devices can be enrolled only by transmission from BR devices. Likewise, UR and RF devices can only be enrolled by transmission from a UR or RF device</p> <p>RF Learning - Two (2) transmissions (2 key depressions) at least five seconds apart, will be required for BR type or four (4) transmissions (fault, restore and fault, restore) for UR or RF type. If the learned serial number has a different loop number than that entered in *56 the system will announce the Voice Descriptor, if it is programmed, followed by two beeps and will return to Prompt (1A) and "L" will be displayed.</p> <p>If the loop number captured by RF transmission and that entered in *56 mode match, the system will announce the Voice Descriptor, if it is programmed, followed by three beeps and return to Prompt (1A) and "LC" will be displayed. No additional transmissions are needed for confirmation.</p> <p>Manual Entry - Enter the 7-digit serial number printed on the transmitter. If you enter an incorrect digit, press the [#] key to backup to prompt (1A) and start over. When all 7 digits are entered, press the [*:] key. If less than 7 digits are entered, the keypad will emit a single long beep and return to the (1A) prompt without displaying the "L".</p> <p>If more than 7 digits have been entered, the first 6 digits will be saved along with the last digit that was entered (entering 123456789 yields the serial number 1234569).</p> <p>Note: If 52 seconds pass and no entry has been made, the system returns to prompt (1A).</p>
<div style="border: 1px solid black; padding: 5px; text-align: center;">F</div>	<p>Delete serial number</p> <p>0 = discard the delete request</p> <p>1 = confirm requested delete</p> <p>Note: Entering a "9" at prompt (1A) will cause the panel to return to prompt (1A) regardless of the confirmation answer.</p>	<p>This function deletes only the serial number.</p> <p>Entering a "9" at prompt (1A). Confirmation of the delete request will cause deletion of the serial number pertaining to the zone being programmed.</p>

Note: In Enhanced Sequential Learn Mode, 4 button type keys will always be learned simultaneously. They will be stopped at the 4 button boundaries of 26, 30, 34 and 38, provided the zone is free of a serial number. If the first zone of the key has a serial number learned, the remaining keys cannot be programmed in sequential learn mode. In addition, if the zone has not been set up (duplicate loop, missing zone type, etc.) only entries 0 (skip to the next zone) and 4 (copy the key template) will be allowed.

*84 Assign Zone Voice Descriptors

Use this mode to assign voice descriptors for each zone. These are the descriptors that are announced when the system announces any event involving a zone number. Each descriptor can consist of up to 3 words.

Press *84 while in Programming mode.

The prompts for *84 are as follows:

84	Voice Descriptors-----Main Menu prompt
A 01	Zone Number -----for entering the zone number to be programmed
b	Descriptor 1-----for assigning the first word of this zone’s descriptor
C	Descriptor 2-----for assigning the second word of this zone’s descriptor
d	Descriptor 3-----for assigning the third word of this zone’s descriptor

The following explains these prompts in detail. The left two columns identify the prompts and list the available entries. The right-most column provides a further explanation of the entries.

Note: Entering a number other than the one specified will give unpredictable results.

84	Assign zone voice descriptors 0 = exit mode 1 = enter mode	Pressing 1 advances to the next prompt below. Pressing 0 exits mode, upon which this prompt blinks, indicating the mode is inactive.
A zz	Zone number [*] = continue to next prompt (any existing descriptors will be announced, then descriptor 1 will be repeated) 00 = exit voice descriptor mode	Enter the 2-digit zone number for which this descriptor is being assigned, then press [*]. The Voice Descriptor for the selected zone will be announced, if it is programmed.
b vv	Descriptor 1 Enter [#] + 2-digit vocabulary index number of first descriptor word for this zone. 6 = accept word and advance to descriptor 2 (descriptor 2 will be announced) 8 = accept word and advance to prompt (A) for next zone. Press any other key to repeat the selected word.	Enter the first word of the descriptor for the selected zone. Use the [6] or [8] key to advance as described. To change the entered index number before pressing [6] or [8], simply press [#] + desired 2-digit vocabulary index number. If descriptor 1 is not desired, enter [#] + 99 (blank), then press [8] to return to zone number prompt.
[vv	Descriptor 2 Enter [#] + 2-digit vocabulary index number of second descriptor word for this zone. 6 = accept word and advance to descriptor 3 (descriptor 3 will be announced) 8 = accept word and advance to prompt (A) for next zone. Press any other key to repeat the selected word.	Enter the second word of the descriptor for the selected zone. Use the [6] or [8] key to advance as described. To change the entered index number before pressing [6] or [8], simply press [#] + desired 2-digit vocabulary index number. If descriptor 2 is not desired, enter [#] + 99 (blank), then press [8] to return to zone number prompt.
d vv	Descriptor 3 Enter [#] + 2-digit vocabulary index number of third descriptor word for this zone. 6 or 8 = accept word and advance to prompt (A) for next zone. Zone descriptor will be announced. Press any other key to repeat the selected word.	Enter the last word of the descriptor for the selected zone. Use the [6] or [8] key to advance as described. To change the entered index number before pressing [6] or [8], simply press [#] + desired 2-digit vocabulary index number. If descriptor 3 is not desired, enter [#] + 99 (blank), then press [8] to return to zone number prompt.

*84 Assign Zone Voice Descriptor

VOICE VOCABULARY INDEX

00 ½ second pause				
	G	P	Z	SYSTEM WORDS AC LOSS ARMED AWAY BYPASSED CHIME DISARMED DISARM SYSTEM NOW EXIT NOW FAULT INSTANT LOW BATTERY NOT READY TO ARM STAY
	48 GARAGE	61 PATIO	81 ZERO	
A	49 GUEST ROOM	62 POLICE	86 ZONES	
82 ALARM	09 GUN	18 POOL		
32 ATTIC		R	29 1 ST	
	H	63 REAR	30 2 ND	
B	50 HALL	19 ROOM	31 3 RD	
01 BABY			70 Custom Word #1	
33 BACK	I	S	71 Custom Word #2	
34 BASEMENT	10 INSIDE	64 SECOND FLOOR	72 Custom Word #3	
35 BATHROOM		65 SEVEN	73 Custom Word #4	
36 BEDROOM	K	20 SHED	74 Custom Word #5	
	51 KITCHEN	21 SHOP		
C		66 SIDE	99 Blank (for erasing a previously programmed word)	
83 CHECK	L	67 SILENT POLICE		
	11 LAUNDRY	68 SIX		
D	52 LAUNDRY ROOM	69 SLIDING		
37 DELAY DOOR	12 LIBRARY	22 SMOKE		
38 DEN	13 LIVING	23 SOUTH		
02 DETECTOR	53 LIVING ROOM	24 STORAGE		
03 DINING		85 SYSTEM		
39 DINING ROOM	M			
04 DOOR	14 MAIN	T	25 THIRD FLOOR	
40 DOWNSTAIRS	15 MASTER	75 THREE	76 TRANSMITTER	
05 DRIVEWAY	54 MASTER BEDROOM	77 TWO		
	55 MEDICAL			
E	84 MESSAGE	U	78 UPSTAIRS	
06 EAST	56 MOTION DETECTOR	26 UTILITY	79 UTILITY ROOM	
41 EIGHT				
42 EMERGENCY	N	W	27 WEST	
	57 NINE	80 WINDOW		
F	16 NORTH			
43 FAMILY ROOM	58 NURSERY	Y	28 YARD	
87 FIRE				
44 FIRE DETECTION	O			
07 FIRST FLOOR	59 OFFICE			
45 FIVE	60 ONE			
08 FLOOR	17 OUTSIDE			
46 FOUR				
47 FRONT				

Notes: (1) If button type device is used to Arm Away, Arm Stay, and disarm the system it is recommended to assign "Check" and "Zones" voice descriptors to each of the three zones. This will allow the system to announce "Check Zones" "Low Battery" if the button device has a low battery.

(2) If a Wireless Keypad is being installed along with this system, not all the voice descriptors shown on this list can be announced by keypad. (Refer to the Wireless Keypad documentation for further information).

*85 Record Custom Voice Descriptors

Use this mode to record up to 5 custom voice descriptors. Press *85 while in Programming mode.

Note: Entering a number other than one specified will give unpredictable results.

<div style="border: 1px solid black; padding: 5px; text-align: center; font-size: 24px; font-weight: bold;">85</div>	<p>Assign custom voice descriptors 0 = exit mode 1 = enter mode</p>	<p>Entering "1" advances to the next prompt below. Entering "0" exits mode, upon which this prompt blinks, indicating the mode is inactive.</p>
<div style="border: 1px solid black; padding: 5px; text-align: center; font-size: 24px; font-weight: bold;">R 7d</div>	<p>Custom descriptor number Enter 7 + d + [*]</p> <p>Where d = 0-4, each representing custom word 70, 71, 72, 73, or 74, respectively. Any existing word will be announced.</p> <p>Press [#] to start recorder. Begin speaking immediately after the third beep. Speak the desired word clearly near the microphone. Recording stops after 1.5 seconds.</p> <p>6 = accept word and ready to record next descriptor prompt (A...7d) [#] = re-record descriptor 00 = exit Record mode after pressing 6 to accept word Press any key to repeat the recorded word.</p>	<p>Record up to 5 custom words.</p>

Voice Prompt Programming

The LYNXR-ENSIA features a quick programming mode that allows you to program the system by responding to a series of voice prompts. The Voice Prompt Programming Guide provides you with the information required to use this feature.



The Voice Prompt Programming feature can not be used to program SIA fire verification zones.

Voice Prompt Programming Keypad Functions:

The keys shown below are used to navigate through the Voice Prompt Programming Feature.

1. **ESCAPE/**OFF **key:** Used at any time to exit the current menu and return to the previous prompt.
2. **ADD/**AWAY **key:** Used to add sensors, or keys or save data when entering phone or account numbers.
3. **DELETE/**STAY **key:** Used to delete a sensor when in the delete Sensors Menu.
4. **SELECT/**AUX **key:** Used to confirm a selection.
5. 3 **↑** key: Used to scroll forward through menu choices.
6. 6 **↓** key: Used to scroll backward through menu choices.
7. **FUNCTION/**# **key:** Used to repeat a voice prompt. (This function cannot be used while entering phone or account numbers.)

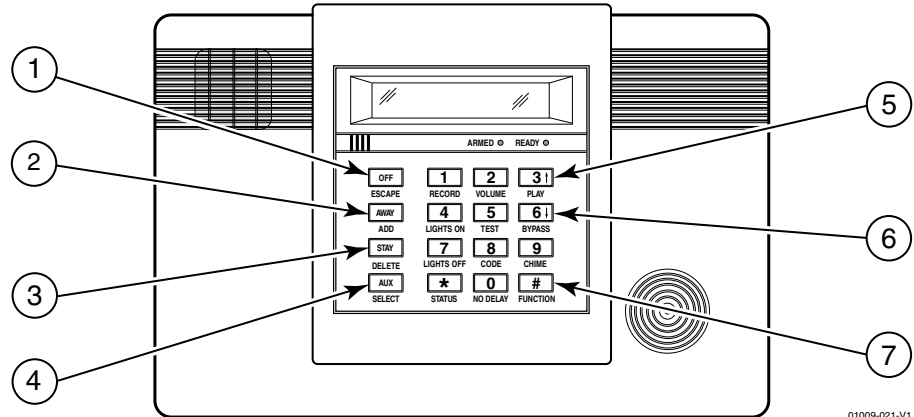

01009-021-V1

- Notes:**
- (1) Keying in any new command will terminate the active voice prompt.
 - (2) If an irrelevant command is entered LYNXR-ENSIA will generate a long rejection beep and repeat the previous voice prompt.
 - (3) Phone numbers and account numbers can be left blank by pressing the “ADD/ AWAY” key without entering any data.
 - (4) LYNXR-ENSIA automatically saves phone and account number data once all available digits are entered.

ENTERING VOICE PROMPT PROGRAMMING

1. Power-up the control and enter the Installer Code (4 1 1 2) + 8 8 8.
2. Once you have entered into the Voice Prompt Programming Mode the system will announce, “Programming, use ARROWS to scroll choices, press SELECT to accept, press ESCAPE to quit.”
3. Press the 6 **↓** or 3 **↑** keys to scroll through the voice menu and follow the instructions provided.
4. The system will announce the following options:
 “Add Sensors”
 “Delete Sensors”
 “First Central Station Phone Number”
 “First Central Station Account Number”
 “Second Central Station Phone Number”
 “Second Central Station Account Number”
 “Templates”
 “Expert Programming Mode”

5. Follow the directions provided by each voice prompt to make your selections.



The **FUNCTION/**# **key can be used to repeat a voice prompt, as required.**

6. When you have completed each programming procedure the system will return to the Main Programming Menu.

EXITING VOICE PROMPT PROGRAMMING

1. Once you have returned to the Main Programming Menu, the system will announce, “Programming use ARROWS to scroll choices, press SELECT to accept, press ESCAPE to quit”.
2. Press **ESCAPE/**OFF **to exit Voice Prompt programming mode once you have returned to the Main Programming Menu.**

Voice Prompt Programming

Enter Voice Prompt Programming Mode: (Installer Code + 8 8 8). Follow the voice prompts to advance to the selected item in the Main Programming Menu.

Add Sensors First Central Station Phone Number Second Central Station Phone Number Templates	Delete Sensors First Central Station Account Number Second Central Station Account Number Expert Programming Mode
---	--

Program each option as shown below. Use the **6** ↓ and **3** ↑ keys to scroll through the voice menu and follow the voice prompts to program the LYNXREN-SIA.



The LYNXR-ENSIA will enroll a sensor once the transmitter has been activated two times. The system will confirm the enrollment following each subsequent activation of the same transmitter.

To Add a Door Sensor

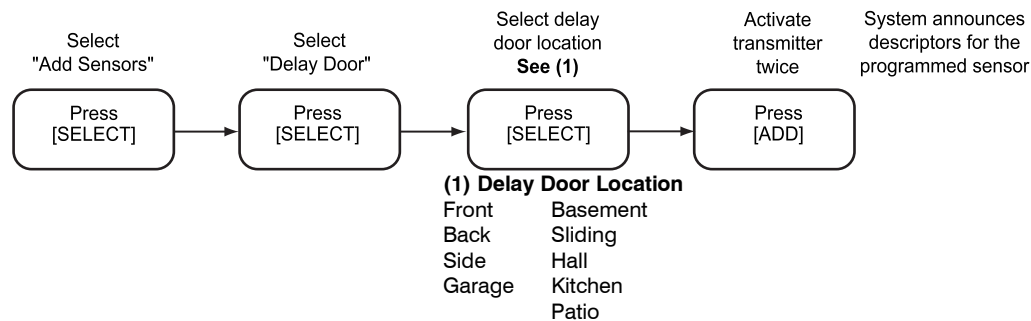

To add a Window, Motion Detector, or Fire Detection Sensor

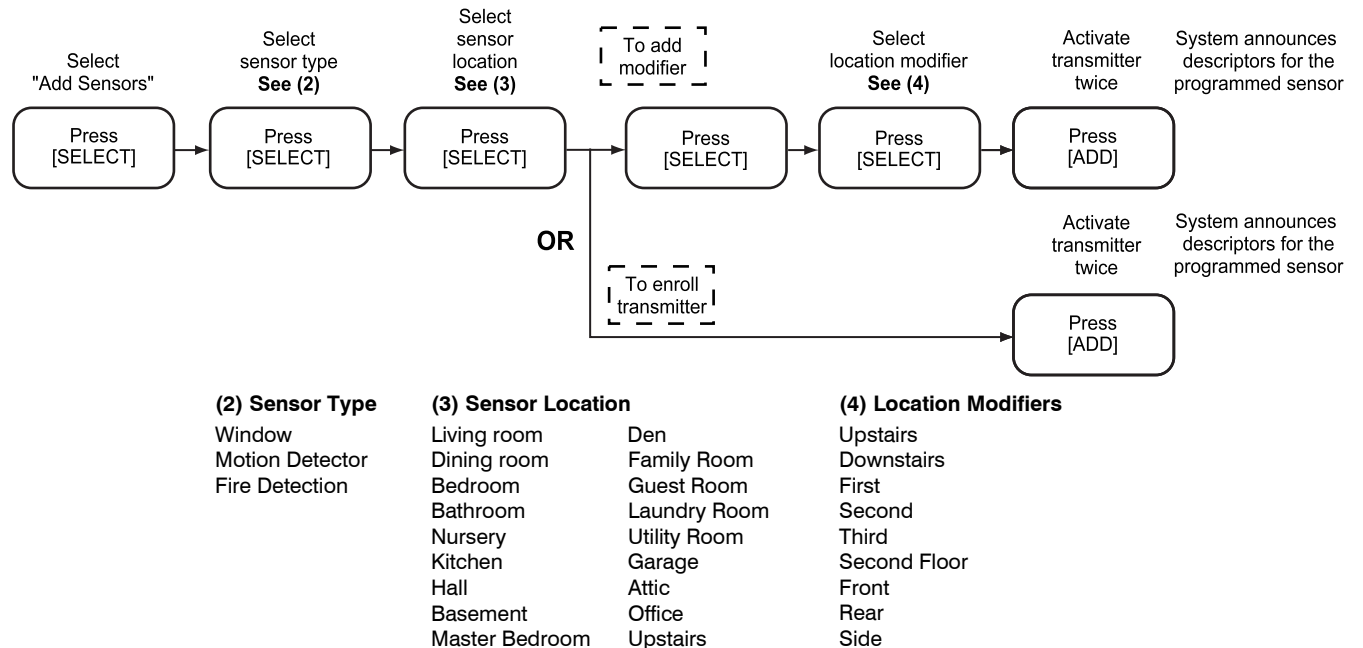

Voice Prompt Programming

To Delete Sensors

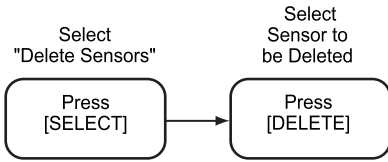

To Add an Emergency Pendant

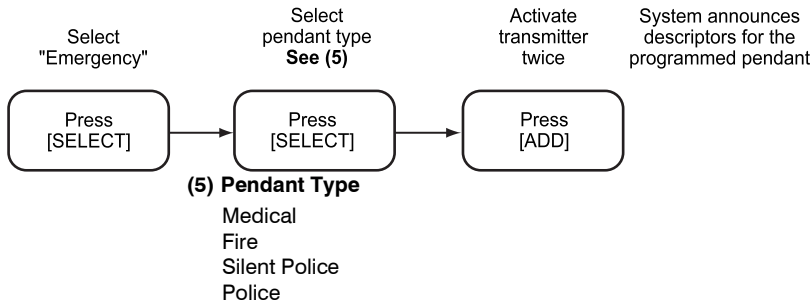

When adding wireless keys, wait 5 seconds between transmissions.

To Add a Wireless Key

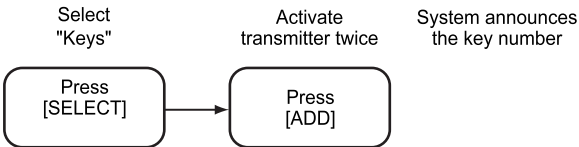

LYNXR-ENSIA automatically saves phone and account number data once all available digits are entered.

To Add First Central Station Phone Number

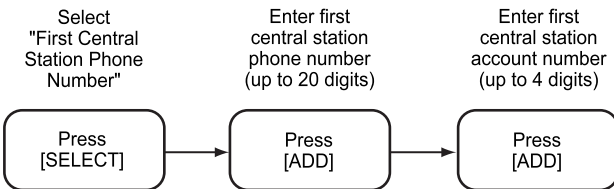

All four digits of the Central Station Account number must be entered. If ten-digit format is selected, all ten digits must be entered.

To Add First Central Station Account Number

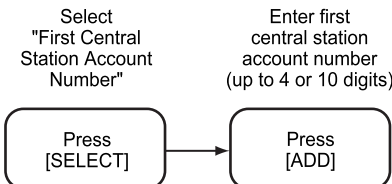

Voice Prompt Programming



All four digits of the Central Station Account number must be entered. If ten-digit format is selected, all ten digits must be entered.

To Add Second Central Station Phone Number

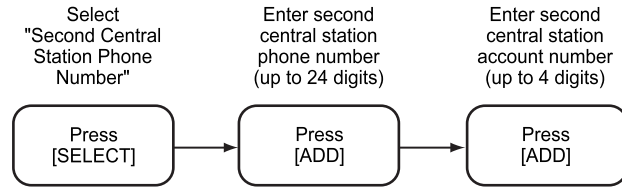

To Add Second Central Station Account Number

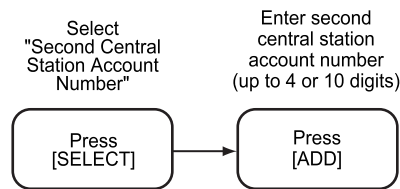

Refer to the LYNXR-ENSIA Series Installation and Setup Guide to view the complete set of Template (default table) selections.

To Program a Template (Default Table)

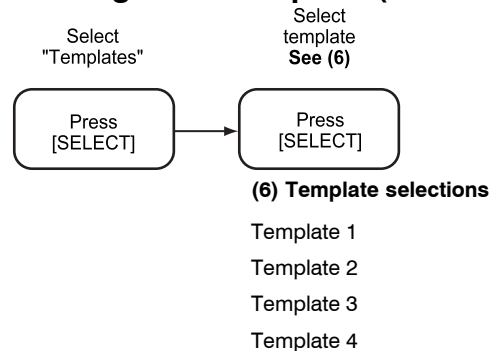

To Enter Expert Programming Mode



Once you have entered the Expert Programming Mode, the [ESCAPE] key can be used to return to the Voice Prompt Programming mode.

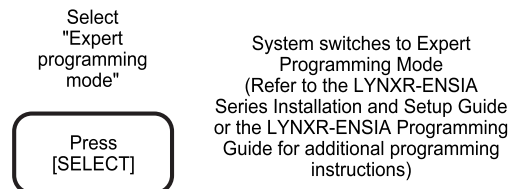

06000-013-V0

Remote Programming/Control (Downloading)

General Information

The control panel can be remotely programmed from an IBM-compatible Personal Computer (PC), a HAYES Modem, and ADEMCO's Compass Downloader for Windows (as specified below).

UL Downloading may only be performed if a technician is at the site.

Multiple security levels protect remote programming against compromise by attempts to defeat the system.

- 1. Security Code Handshake:** An 8-digit download ID code must be matched between the Control and downloader.
- 2. Site-Initiated Remote Programming:** The installer or subscriber initiates the call from the subscriber premises (by entering Installer Code + # + 1) while disarmed. All parameters can then be downloaded via the phone lines using a personal computer.
- 3. Station-Initiated Remote Programming:** The operator calls the site from your office to initiate the download call. The Control hangs up and then calls back the PC via the preprogrammed telephone number. The unit can then be uploaded, downloaded, or controlled from your office.
- 4. Telco Handoff:** The installer or subscriber performs a download session on the call initiated from the site or from local laptop computer (by entering Installer or Master Code + # + 1 at the control panel).
- 5. Data Encryption:** Data passed between the PC and the Control is encrypted for security so that it is very difficult for a foreign device tapped into the phone line to take over communication and substitute system-compromising information.

Equipment required to download to a system at the premises

- An IBM PC compatible computer and appropriate interconnecting cables.
- *Either* a HAYES brand SMARTMODEM 1200 (Level 1.2 or higher external or Level 1.1 or higher [with 4 position DIP switch] internal style), a HAYES brand Optima 336 external, a HAYES brand Optima 24 Plus FAX96, or an Ademco CIA Modem.
- Compass Downloader for Windows (at revision level supporting LYNXR-ENSIA).

Initial Download: Enter **Installer Code + # + 5**. This sets field *95 to 4 rings, and system to "no call-back" option. The download computer can then call the subscriber, make connection, and download all programming data.

Flexible Callback: If enabled in field *93, the download operator can temporarily change the last 1, 2, or 3 digits (depending on selection) of the call back number. This allows the control to call back a computer other than the one programmed, which may be helpful at times of high computer traffic. See field *93 for a full description.

Remote Programming Information



LYNX must be connected to the telephone line if using Remote Programming.

The downloading system can perform many functions when in communication with the Control. Besides uploading and downloading, the status of the system can be observed and various commands can be initiated, as follows:

- Arm the system in the away mode; disarm the system.
- Bypass a zone.
- Force the system to accept a new program download.
- Shut down communication (dialer) functions (for nonpayment of monitoring fees in an owned system).
- Shut down all security system functions (for nonpayment for a leased system).
- Inhibit local keypad programming (prevents account takeover).

Remote Programming/Control (Downloading)

- Command the system to upload a copy of its resident program to the office.
- Set the time
- View/Modify
- X-10/ Scheduling
- Read: arming status, AC power status, lists of faulted zones, bypassed zones, zones currently in alarm, zones currently in trouble, and RF sensors with low battery conditions; read control's time.

Notes: (1) After the control and the PC have established valid communication, the keypad will become inactive and will display "CC."
(2) The keypad will become active after the download communication is terminated.
(3) The detailed operation of the download functions is covered in the installation instructions for the Compass Downloader for Windows.

Remote Programming Advisory Notes

- Keypad entries are ignored during the time interval stated above.
- A copy of the program downloaded may be printed using the IBM PC-compatible computer's internal report generator, when an optional printer is connected (consult your PC manual for proper printer and connections).
- Program upload or download time is approximately one minute, fifteen seconds for a complete program.

System Operation

Security Codes

Installer Code

The installer programs the 4-digit Installer Code initially as part of the programming procedure. The factory default Installer Code is 4-1-1-2, but may be changed in field *20.

The Installer Code is the only code that can enter Programming mode and also, in normal operation mode, is used to enter the Master Code, which allows access to the normal functions of the system.

Master Code

In normal operation mode, the Installer Code is used to enter the 4-digit Master Security Code.

To enter/change the Master code by installer, using the keypad enter:

Installer Code + [CODE key] + [02] + desired 4-digit Master Code

To change the Master code by master, using the keypad enter:

Current Master Code + [CODE key] + [02] + new Master Code + new Master Code again

Secondary User Codes

In normal operation mode, the Master Security Code can be used to assign up to 6 secondary 4-digit security codes, including a Babysitter Code and a Duress Code. The Master Code can also be used to remove secondary codes from the system (individually).

To assign (or change) a secondary security code, using the keypad enter:

Master Code + [CODE key] + User # (03-08) + desired Secondary Code

The system will emit a single beep when each secondary code has been successfully entered.

To delete a secondary security code, using the keypad enter:

Master Code + [CODE key] + User # (03-08)

Security Code Notes

- The Master and Secondary security codes permit access to the system for arming, disarming, etc.
- The Installer Code can disarm the system only if it was used to arm it. In addition, the Installer Code cannot disarm the system if it was armed by pressing and holding a Quick-Arm button.
- The Babysitter Code (User Code No. 7) can disarm the system only if it was used to arm it. In addition, the Babysitter Code cannot disarm the system if it was armed by pressing and holding a Quick-Arm button.
- Duress code (User Code No. 8) sends a special code to the monitoring station when used to perform any system operation. Instruct users not to use this code for normal usage. If the duress code is programmed, you must enter a report code for Zone 92 (duress).
- If a secondary code is inadvertently repeated for different users, the lower user number will take priority.
- Opening/closing reports are sent for the Installer Code as No. 01, with the appropriate subscriber number. Master Code and set of secondary user codes are sent as Nos. 02 and 03-08, respectively, in Contact ID® format (with the appropriate user number); in 4+2, it is 1-8. Quick arming (and open/close executed by downloader) is reported as user 00.

Panic Keys

There are three panic key pairs that, if programmed, can be used to manually initiate alarms and send a report to the central station.

Each can be individually programmed for 24-hour silent, audible, personal or fire emergency responses. The panic function is activated when both keys of the appropriate key pair are pressed at the same time.

The panic functions are identified by the system as follows:

Keys	Displayed as Zone
[1] & [*]	95
[*] & [#]	99
[3] & [#]	96

Important: For the silent panic functions to be of practical value, the system must be connected to a central station.

System Operation

Keypad Functions

The keypad allows the user to arm and disarm the system, and perform other system functions, such as bypassing zones. Zone and system conditions (alarm, trouble, bypass) are displayed in the display window. When an alarm occurs, keypad sounding and external sounding will occur, and the zone(s) in alarm will be displayed on the keypad. Pressing any key will silence the keypad sounder for 10 seconds (only once). Disarming the system will silence both keypad and external sounders. When the system is disarmed, any zones that were in an alarm condition during the armed period will be displayed (memory of alarm). To clear this display, simply repeat the disarm sequence (enter the security code and press the OFF key). The keypad also features chime annunciation, and 3 panic key pairs for silent, audible, fire or personal emergency alarms. These keys can notify the central station of an alarm condition, if that service is connected. A summary of system functions is provided below for more detailed information refer to the User's Manual.

Security Functions (Empty boxes represent the user's security code)

Checking system status: ----- (STATUS) (high level messages); press (STATUS) again for secondary messages

To arm in STAY mode: ----- + (STAY) (or installer code + [3])

To restart exit delay: ----- (STAY) (applies only if system is armed in Stay mode)

To arm in AWAY mode: ----- + (AWAY) (or installer code + [2])

To arm with NO DELAY:----- + (AWAY) or (STAY) + (NO DELAY)

To arm if Quick Arm is programmed: - (AWAY) or (STAY) (hold down for at least 2 seconds)

To disarm the system and silence alarms: + (OFF)

Note: During Entry Delay or when an Alarm Condition exists the system can be disarmed by entering the User Code. Entering the (OFF) key is not required.

To bypass a zone(s): ----- + (BYPASS) + 2-digit zone number(s)

To turn Chime mode on or off: ----- (FUNCTION) + (CHIME)

Message Center

To record a message: ----- (FUNCTION) + (RECORD)

To stop recording before end of 90 seconds: (OFF)

To play back a message: ----- (FUNCTION) + (PLAY)

To skip a message: ----- [*]

To delete all messages:----- (FUNCTION) + (DELETE) (during message replay)

Volume Control

To adjust message playback/system announcement volume: (FUNCTION) + (VOLUME) + [3] or [6]

To mute system announcements: (FUNCTION) + (VOLUME) + (OFF)

To restore/unmute announcement & volume: (FUNCTION) + (VOLUME) + [3] or [6]

Other Functions

To set the time and date: ----- + (FUNCTION) + [63]

To set the scheduling: ----- + (FUNCTION) + [64]

To activate or deactivate X-10 devices 1-6: (FUNCTION) + (LIGHTS ON) or (LIGHTS OFF) + device number

To activate or deactivate X-10 devices 7 & 8: + (FUNCTION) + (LIGHTS ON) or (LIGHTS OFF) + dev. No.

To add a user code: ----- * + (CODE) + user number + user's code (*master code)

To delete a user code (except Master Code): * + (CODE) + user number (* master code)

To turn Test mode on: ----- + (TEST)

To turn Test mode off: ----- + (OFF)

To use the defined AUX function: Press and hold (AUX) key 2 secs (4 beeps) +

System Operation

To define AUX function: + FUNCTION + AUX + action separated by + AUX terminated by + AUX + AUX

To send message to pager: Press and hold AUX key 2 seconds (4 beeps)

To program Follow Me Reminder telephone number: + FUNCTION + [65]

Speaker Phone Operation

To place a call or answer a call using the speaker phone: [#] + AUX

To flash (switch between two calls using call waiting): AUX

To hang up and exit speaker phone mode: OFF

To enable/disable (toggle) ringer: [#] + VOLUME + AUX

To return the keypad to telephone mode after disarming the system: [#] + AUX

NOTE

The ARMED and READY LEDs blink alternately when the Speaker Phone is active.

Remote Phone Control Feature

The remote phone control feature, which must be enabled in field *91, allows the user to access the security system from any off-site touch-tone telephone. The control will pick up the incoming call, based on the ring count specified in field *95, and will announce "SYSTEM ENTER CODE" every three (3) seconds for the next eight (8) seconds. During this period the panel will wait for a valid User Code to be entered. If a valid User Code is not entered or the eight (8) second period expires a modem tone will be generated for remote programming (Compass Downloading). If a valid User Code has been entered, the control will announce the current system status and/or beeping sounds.

Keypad Functions

Remote Phone Control Feature

To remotely disarm system: ---- + [1]

To remotely arm in AWAY mode: + [2]

To remotely arm in STAY mode: + [3]

To remotely arm in AWAY or STAY with no delay: + [2] or [3] + [0]

To remotely activate X-10 devices 1-6: [#] + [4] + device no.

To remotely activate X-10 devices 7 & 8: + [#] + [4] + device no.

To remotely deactivate X-10 devices 1-6: [#] + [7] + device no.

To remotely deactivate X-10 devices 7 & 8: + [#] + [7] + device no.

To remotely Bypass zones: ---- + [6] + zone no.

To remotely activate Forced Bypass: + [6] + [#]

To remotely check system status: [*]

To end remote phone control session: Hang Up or enter + [9]

Quick Arm Note

The installer code and babysitter code cannot disarm the system if armed by Quick Arm method.

System Operation



Alarm audio verification cannot be used for UL installations.

Alarm Audio Verification (Two-Way Voice Feature)

This feature allows the central station operator to listen, talk to or conduct a two-way conversation with an individual(s) at the premises. It also assists the operator in gathering information about the nature and location of the alarm that may be helpful in responding to police and fire departments. All LYNXR-ENSIA control panels are capable of supporting the Two-Way Voice feature. The LYNXR-ENSIA does not make system announcements when the Two-Way voice feature is active.

Activation

The LYNXR-ENSIA sends the “alarm message” followed by a “Listen-in-to-Follow message” (Contact ID® code 606) to the Central Station. The Listen-in-to-Follow message causes the Central Station’s digital receiver to temporarily hold the phone line for approximately 1-minute. When the LYNXR-ENSIA receives the “kissoff” from the central station, indicating that the alarm message has been received, the Two-Way Voice (AVM) feature is activated in the (default) “Listen Mode” and sirens and keypad sounds are discontinued. The LYNXR-ENSIA transmits a beep acknowledgment to the Central Station, once per second. The beep alternates between two tones and indicates that the LYNXR-ENSIA is waiting for a session command from the Central Station operator. Once a command is issued the beep acknowledgement is discontinued, however, if a command is not issued within two minutes the system will “time out” and the call will be terminated.

Operator Commands

The Central Station operator begins the session, which last 5 minutes, by entering one of the valid AVM commands shown in the table below. The session may be extended 5 minutes, without changing the operating mode, by pressing the [7] key on the touch-tone phone. Selecting another operating mode also resets the session an additional 5 minutes. During the last minute of the 5 minute, session, the LYNXR-ENSIA generates two beeps every 30 seconds to alert the Central Station operator that the session is about to time out. The Central Station operator may then extend the session by pressing the [7] key on the touch-tone phone. If the session is not extended the phone line is disconnected, and the session is ended. Sessions may be ended at any time by pressing the [9] key on the touch-tone phone. The AVM modes are described as follows:

Note: When entering AVM commands make sure the Central Station receiver has been disconnected from the phone line, otherwise AVM commands may not go through.

Key	Function
1	Talk Mode: Pressing the [1] key on the touch tone phone, enables one-way voice communication from the central station to the violated premises, and allows the operator to talk communicate through the LYNXR-ENSIA speaker. In this mode the ARMED (red) and READY (green) LEDs blink alternately.
2	VOX (Voice) Mode: Pressing the [2] key on the touch-tone phone, enables two-way voice communications between the central station and the violated premises. In this mode the ARMED (red) and READY (green) LEDs blink alternately.
3	Listen Mode: Pressing the [3] key on the touch-tone phone, enables one-way audio from the violated premises to the central station. The Listen Mode is the start up default mode of the voice feature and allows the operator to listen through the LYNXR-ENSIA microphone. This mode does not affect the existing LED pattern.
7	Extends the session 5 minutes without changing its operating mode.
9	Ends the session and disconnects the phone line.

System Operation

“Follow Me” Reminder Feature

This feature allows the user to schedule a time driven message. When activated the system will dial a phone number, that the installer programs in Field *46, and deliver a voice message (custom words 72, 73, and 74). The LYNXR-ENSIA will immediately begin transmitting the voice message and will repeat the message for 45 seconds. Pressing any touch-tone key on the answering phone will acknowledge the message ending the session and preventing the system from redialing the programmed number. Delivery of a reminder message on the local LYNXR-ENSIA keypad will continue. If the message has timed out the system

will redial the programmed number a maximum of seven additional times or until it is acknowledged. Pressing any key on the LYNXR-ENSIA keypad will terminate (acknowledge) both the follow me reminder and the local reminder announcements.

Notes: (1) This feature is only supported if programmed in field *49.
(2) The follow me reminder will be terminated if any other event requires the system to dial out, or if an audible alarm has occurred, however, delivery of the local schedule reminder message will continue.

“Follow Me” System Announcement Feature

This feature allows the LYNXR-ENSIA to deliver a voice system message to the secondary phone number programmed by the installer. The LYNXR-ENSIA will first transmit reports to the Central Station and after receiving its kiss-off the system will dial the secondary phone number and begin transmitting the voice message. This message is a repeatable system status announcement. Like the Follow Me reminder, pressing any key on the answering telephone or the local LYNXR-ENSIA keypad will terminate (acknowledge) the message. The system will dial the secondary phone number a maximum of eight times. The Follow Me alarm functions may be triggered by a variety of events depending upon the selections made during programming in field *49.

Note: The follow me system announcement will be terminated if any other event requires the system to dial out or if an audible alarm has occurred.

Powerline Carrier Devices (e.g. X-10 devices)

If Powerline Carrier Devices are used, two keypad entries available to the user are included. They can manually activate or deactivate the device(s) for starting or stopping some action, such as turning lights on or off, etc.

These keypad entries are:

Security Code* + [#] + [4] + Device # activates (starts) that device.

Security Code* + [#] + [7] + Device # de-activates (stops) that device.

*Code is required for devices 7 and 8. Code is not required for devices 1-6.

Exit Error Alarm Displays

If programmed:

- **A display of “CA” and a zone indication** will appear if an exit or interior zone contained a fault during closing at the time the exit delay ended (e.g., exit door left open), **but the system was disarmed during the entry delay time.** The alarm sounder and keypad sound continuously, but stop when the system is disarmed. No message will be transmitted to the central station.
- **A display of “EA” and a zone indication** will appear if an exit or interior zone contained a fault during closing at the time the exit delay ended, **but the system was NOT disarmed during the entry delay time.** The alarm sounder and keypad sound continuously until the system is disarmed (or timeout occurs). An Exit Alarm message is sent to the central station.
- **The “EA” display, etc.** will also result if an alarm from an exit or interior zone occurs within two minutes after the end of an exit delay.

In any of the above cases, use a second OFF sequence (code plus OFF key) to clear the display.

System Operation

Trouble Conditions

The word “FAULT” on the keypad’s display, accompanied by a rapid “beeping” at the keypad, indicates that there is a trouble condition in the system. Pressing any key can silence the audible warning sound. Instruct users to call for service immediately upon seeing any of the following messages.

“Fault” and “Battery” Displays

- **“FAULT” and one or more zone numbers** indicates that a problem exists with the displayed zone(s) and requires attention. After correcting the problem, the display can be cleared by entering the security code plus the OFF key twice.
- The fault condition may also be caused by some change in the environment that prevents the built-in receiver from receiving signals from a particular wireless sensor.
- **“LOW BAT” with no zone number** indicates that the system’s backup battery is weak.
- **“LOW BAT” with a zone number** and a once-per-45 seconds “beeping” at the keypad indicates that a low battery condition exists in the wireless sensor displayed (zone “00” indicates a wireless button/keypad). If the battery is not replaced within 30 days, a “FAULT” display may occur.

Power Failure

- **If there is no display at all, and both indicators are not lit**, operating power for the system has stopped and the system is inoperative.
- **If the display is lit and the AC display is off**, the system is operating on battery power only.
- **During an AC power loss**, the backlighting will turn off and the indicators will flicker slightly to minimize deep discharge of the battery.

Other Displays

dI = Busy-Standby: Displayed upon power-up. After approximately 1 minute* the green “READY” LED should light. If the “dI” remains displayed for more than 1 minute, the system is disabled.

*To bypass the 1-minute delay, press [#] + [0]. Important: Do not try to bypass 1minute delay before “dI” is displayed!

CC = Modem Comm: The system is communicating with the central station for change of function or status verification.

FC = Comm. Failure: A communication failure has occurred. This message clears only when the system is subsequently armed.

90 = RF Jam: The system has detected an RF jamming condition or excessive interference.

PH = Speaker Phone Mode: The system is in Speaker Phone mode.

PC = Phone Control: The remote Phone Control feature is active.

Testing the System

Test Mode

After installation is completed, the security system should be carefully tested, as follows.

1. With the system in the disarmed state, check that all zones are intact. If the **READY** LED is not lit, press the [*] key to display the faulted zone(s). Restore faulted zone(s) if necessary, so that **READY** LED lights. Fault and restore every sensor individually to assure that it is being monitored by the system.
2. Enter the **security code** and press the **TEST** key. The outside sounder will sound for 1 second and all the LED segments on the keypad display light for 3 seconds. LYNX announces the zone's voice descriptor (if programmed) followed by 3 beeps, each time a contact is faulted. A test report will be transmitted to the central station immediately. If the backup battery is discharged or missing, the sounder may not turn on and a **LOW BATTERY** report will be transmitted with a **TEST** report. The keypad will beep once every 45 seconds as a reminder that the system is in the Test mode.
3. To turn off the Test mode enter **security code** and press the **OFF** key.

- Notes:**
- (1) Triggering a zone set to Arm AWAY, Arm STAY, or Disarm will take the system out of Test and cause that action.
 - (2) BR type transmitters do not display during Test mode (keypad beeps only)
 - (3) Macros cannot be run from the Test mode.
 - (4) Test mode automatically ends after 4 hours. During the final 5 minutes (after 3 hours 55 minutes of Test mode), "TEST" flashes on the keypad indicating that the end of Test mode is nearing.
 - (5) Upon termination of a test mode all faulted 24-hour zones are treated as a trouble zones.
 - (6) Fire verification is disabled when the system is in Test mode.

Armed System Test

Alarm messages will be sent to the central station during steps 1 and 2. Notify them in advance that the test will be in progress.

1. Arm the system and fault one or more zones. After 15-45 seconds (if optional burglary abort window is selected), silence alarm sounder(s) by entering the **code**. Check entry/exit delay zones.
2. Check the keypad-initiated alarms that are in the system by pressing the Panic key pairs. If the system has been programmed for audible emergency, the keypad will emit a steady alarm sound, and "**ALARM**" and **zone number** will be displayed. Silence the alarm by entering the **security code**. If the system has been programmed for silent emergency, there will be no audible alarms or displays, but a report will be sent to the central station.
3. If Powerline Carrier Devices have been installed, test their programmed action.
4. Notify the central station when all tests are finished, and verify results with them.
5. To test the wireless part of the system and the RF receiver, perform the two additional functions described in the *Installing Wireless Zones* section: Sniffer mode and Go/No Go Test.

Note: **System Test mode** (installer/master code + test) and **Go/No Go Test** (installer code + # + 8) will be **automatically terminated** after 3-1/2 to 4 hours if the installer or user does not manually terminate it. This ensures that fire and panic zones will not remain disabled.

TO THE INSTALLER

Regular maintenance and inspection (at least annually) by the installer and frequent testing by the user are vital to continuous satisfactory operation of any alarm system.

The installer should assume the responsibility of developing and offering a regular maintenance program to the user as well as acquainting the user with the proper operation and limitations of the alarm system and its component parts. Recommendations must be included for a specific program of frequent testing (at least weekly) to ensure the system's proper operation at all times.

System Communication

This section provides an explanation of formats this system accommodates for reporting alarms and other system conditions to the central station. The process of a successful transmission consists of both the method of communication between the control panel and the central station receiver, and the actual way the information is sent and displayed at the central station.

Communication Overview

When the panel calls the central station receiver, it waits to hear a “handshake” frequency from the receiver to confirm that the receiver is on-line and ready to receive its message. Once the panel hears the handshake it is programmed to listen for, it sends its message. The panel then waits for a “kissoff” frequency from the receiver acknowledging that the message was received and understood.

If the handshake frequency is not given or is not understood by the panel, the panel will not send its message. Once the handshake frequency is received and understood by the panel, the panel will send its message. If there is an error in the transmission (the receiver does not receive a “valid” message), the kissoff frequency will not be given by the central station receiver.

The panel will make eight attempts to the primary telephone number and eight attempts to the secondary telephone number (if programmed) to get a valid message through. If the panel is not successful after its numerous attempts, the keypad will display “FC.” If the secondary number is a pager, “FC” displays after the first 8 attempts to the primary number.

The following chart defines the three sets of (handshake/kissoff) frequencies that the panel supports, and the different formats that can be sent for each.

FORMAT	HANDSHAKE	TRANSMITS DATA	KISSOFF	TRANSMIT TIME
Low Speed	1400Hz	1900Hz (10PPS)	1400Hz	Under 15 seconds
3+1 4+1 4+2 Sescoa/Rad	2300Hz	(Standard report) 1900Hz (20PPS)	2300Hz	Under 10 seconds
3+1 4+1 4+2 Express	1400–2300Hz	(Standard report) DTMF (10 cps)	1400Hz	Under 3 seconds
4+2 Contact ID®	1400–2300Hz	DTMF (10 cps)	1400Hz	Under 3 seconds

Report Code Formats

3+1 and 4+1 Standard Formats	Comprise a 3- (or 4-) digit subscriber number and a single digit report code (e.g. alarm, trouble, restore, open, close, etc).
3+1 and 4+1 Expanded Formats	Comprise a 3- (or 4-) digit subscriber number, and a 2-digit report code. The first digit is displayed on the first line, followed by a second line where the first digit is repeated 3 (or 4) times and followed by the second digit. This is the “expanded” digit.
4+2 Format	Comprises a 4-digit subscriber number and 2-digit report code.
ADEMCO Contact ID®	Comprises a 4-digit subscriber number, 1-digit event qualifier
Reporting Format	(“new” or “restore”), 3-digit event code, and 3-digit zone number, user number, or system status number (see the following page).

The following table shows the message formats for 3+1, 4+1 and 4+2 reports, where:

SSS or SSSS = Subscriber ID	C = Close Code (1st Digit)
A = Alarm Code (1st digit)	U = User Number (in hex)
Z = Typically Zone Number* (2nd digit)	Gg = Test Code (1st & 2nd digits)
Tt = Trouble Code (1st & 2nd digits)	R = Alarm Restore Code
Bb = Bypass Code (1st & 2nd digits)	R _T t = Trouble Restore Code (1st & 2nd digits)
EAC = AC Loss Code (1st & 2nd digits)	R _B b = Bypass Restore Code (1st & 2nd digits)
LLB = Low Battery Code (1st & 2nd digits)	R _A AC = AC Restore Code (1st & 2nd digits)
O = Open Code (1st Digit)	R _L LB = Battery Restore Code (1st & 2nd digits)

Zone numbers for: [] & [#], or [B] = 99; [1] + [*], or [A] = 95; [3] + [#], or [C] = 96; Duress = 92

System Communication

Report	3+1/4+1 Standard	3+1/4+1 Expanded	4+2
Alarm	SSS(S) A	SSS(S) A AAA(A) Z	SSSS AZ
Trouble	SSS(S) T	SSS(S) T TTT(T) t	SSSS Tt
Bypass	SSS(S) B	SSS(S) B BBB(B) b	SSSS Bb
AC Loss	SSS(S) E	SSS(S) E EEE(E) A _C	SSSS EA _C
Low Battery	SSS(S) L	SSS(S) L LLL(L) L _B	SSSS LL _B
Open	SSS(S) O	SSS(S) O OOO(O) U	SSSS OU
Close	SSS(S) C	SSS(S) C CCC® U	SSSS CU
Test	SSS(S) G	SSS(S) G GGG(G)g	SSSS Gg
Restore Alarm	SSS(S) R	SSS(S) R RRR® Z	SSSS RZ
AC Restore	SSS(S) R _A	SSS(S) R _A R _A R _A R _A (R _A)A _c	SSSSR _A A _c
Low Battery Restore	SSS(S) R _L	SSS(S) R _L R _L R _L R _L (R _L)L _B	SSSS R _L L _B
Trouble Restore	SSS(S) R _T	SSS(S) R _T R _T R _T R _T (R _T)t	SSSS R _T t
Bypass Restore	SSS(S) R _B	SSS(S) R _B R _B R _B R _B (R _B)b	SSSS R _B b

ADEMCO Contact ID® Reporting takes the following format: CCCC Q EEE GG ZZZ where:

CCCC = Customer (subscriber) ID

Q = Event qualifier, where: E = new event, and R = restore

EEE = Event code (3 hex digits) (for a complete list of event codes, refer to the central office receiver manual)

GG = Always “00”

ZZZ = Zone/Contact ID® number reporting the alarm, or user number for open/close reports. System status messages (AC Loss, Walk Test, etc.) contain zeroes in the ZZZ location.

CONTACT ID® EVENT CODES

Code	Definition
110	Fire Alarm
121	Duress
122	Alarm, 24-hour Silent
123	Alarm, 24-hour Audible
131	Alarm, Perimeter
132	Alarm, Interior
134	Alarm, Entry/Exit
135	Alarm, Day/Night
146	Silent Burglary
150	Alarm, 24-Hour Auxiliary
301	AC Power
302	Low System Battery/Battery Test Fail
344	RF Jam Detected
373	Fire Loop Trouble
374	Exit Error Alarm
380	Global Trouble, Trouble Day/Night
381	RF Supervision Trouble
383	RF Sensor Tamper (Trouble)
384	RF Sensor Low Battery

Code	Definition
401	Disarmed, Armed AWAY (NO DELAY), Armed AWAY
403	Scheduled Auto Arm
406	Cancel by User
407	Remote Arm/Disarm (Downloading)
408	Quick Arm AWAY/NO DELAY
441	Disarmed/Armed STAY/NO DELAY, Quick Arm STAY/NO DELAY
459	Recent Close
570	Bypass
602	Periodic Test
606	AAV to follow
607	System Test
623	Event Log 80% Full
654	System Inactivity

Note: The following codes are logged in the event log upon occurrence, but are not reported:

305 = System Reset

627 = Keypad Program Mode Entry

Troubleshooting Guide

SYSTEM (including Wireless)

SYMPTOM	POSSIBLE CAUSE	REMEDY
1. Transmitter signal not received at control.	1a. Transmitter not properly powered. 1b. Transmitter is located too far from RF receiver. 1c. There is metal shielding between transmitter and RF receiver. 1d. Transmitter is malfunctioning. 1e. Transmitter No. (zone) is not programmed.	1a. Check or change transmitter's battery. 1b. Move transmitter or RF receiver. 1c. Check for large metal obstructions, then relocate transmitter if necessary. 1d. Verify by activating control with another, similar transmitter. If O.K. now, return defective transmitter. 1e. Verify programming.
2. Transmitter zone number appears during Transmitter Sniffer mode, but does not clear.	2a. Transmitter zone type (ZT) is set to 00 (Not Used). 2b. Transmitter battery not installed. 2c. 5800 System transmitter not "entered" in system.	2a. Set ZT to a valid active zone type in field *56. 2b. Install proper battery. 2c. "Enter" unit in field *56 or *83.
3. Low battery message on keypad. 3a. "Low Bat" (no zone Nos.) 3b. "Low Bat" + "00". 3c. "Low Bat" + "nn".	3a. System battery is low or missing. 3b. Remote RF keypad/button battery is low. 3c. Transmitter for zone "nn" has a low battery.	3a. Replace system battery. 3b. Replace battery in the RF keypad. 3c. Replace the battery in the displayed transmitter.
4. Periodic beep(s) from keypad.	4a. System is in Test mode. 4b. A transmitter low battery has occurred and is displayed. 4c. A supervision fault has occurred. 4d. System low battery	4a. Enter Code + OFF to exit Test mode. 4b. Enter Code + OFF and replace the battery. 4c. Check the transmitter indicated. Restore communication to the receiver to cancel the condition. 4d. Replace system battery
5. No response to a transmitter in normal operation, although zone number clears during Transmitter Sniffer mode.	Put control in Test mode. If zone does not respond, try operating the tamper switch or another input to the transmitter. 5a. If another input causes the zone to be displayed, the wrong input was "entered" when programming. 5b. If no response at all from this transmitter, this physical transmitter has not been entered by the system. Transmitter Sniffer display is being cleared by another unit programmed for this zone.	5a. Delete input's serial number (not the zone), and enter the proper input (see field *56). 5b. Determine which transmitter is programmed for this zone and reprogram as necessary.
6. Nuisance or phantom alarm.	6a. Sensors not properly installed, wired, or monitored. 6b. Universal transmitter (5817) programmed wrong.	6a. Check installation to see if in accordance with established procedure. 6b. Check programming switches on transmitter.
7. Intrusion alarm for no apparent reason.	7a. Protected door or window opened while system armed. 7b. Improper user operation of exit/entry delays. 7c. Magnets located too far from switches, and/or doors and windows not properly aligned.	7a. Check with all occupants of protected home. 7b. Check setting of entry and exit delays. 7c. Check all openings for proper switch and magnet orientation.

Troubleshooting Guide

CONTROL

SYMPTOM	POSSIBLE CAUSE	REMEDY
1. The word "AC" is not displayed.	1a. Interrupted AC power supply.	1a. Check transformer connection and powerline circuit breaker.
2. Digital communicator message not being received.	2a. System in Test mode. 2b. Telephone connection not secure. 2c. Digital communicator malfunctioning. 2d. Telephone number in program needs prefix or access code. 2e. Telephone call to central monitoring station requires operator assistance.	2a. Remove from Test mode. 2b. Check all connections. 2c. Check with a different CONTROL PANEL. 2d. Program prefix or access code into the CONTROL PANEL. 2e. System cannot work in this situation.
3. Does not arm properly. READY light not on.	Open or faulted zone(s)	Check for faulted zones and make intact, or use Bypass arming, if desired.
4. System doesn't respond to keystrokes on keypad. 4a. "CC" displayed. 4b. "d1" displayed.	4a. System is in communication with downloader at central station. 4b. System has just been powered and is in its one minute initialization.	4a. Wait until download session is finished. 4b. Wait for initialization to finish, or bypass this time by pressing '#' + '0.'

SMOKE DETECTOR

SYMPTOM	POSSIBLE CAUSE	REMEDY
1. Detector alarms, no apparent reason.	1a. Dust, dirt in sensing chamber. 1b. Improper location. 1c. Unit malfunctioning.	1a. Clean unit's sensing chamber with vacuum cleaner per unit's instructions. 1b. See unit's instructions for locations to avoid. Relocate as necessary. 1c. Replace detector.
2. Detector's siren sounds.	2a. Unit not receiving required power. 2b. Unit malfunctioning.	2a. Check for proper installation of battery. Try new battery. 2b. Replace detector.

Contacting Technical Support

PLEASE, before you call Technical Support, be sure you:

- **READ THE INSTRUCTIONS!**
- **Check all wiring connections.**
- **Determine that the power supply and/or backup battery are supplying proper voltages.**
- **Verify your programming information where applicable.**
- **Note the proper model number of this product, and the version level (if known) along with any documentation that came with the product.**
- **Note your ADEMCO customer number and/or company name.**

Having this information handy will make it easier for us to serve you quickly and effectively.

You may contact Technical Support via Toll Free Fax. Please include your return fax number. You will receive a reply within 24 hours.

Technical Support: 1-800-645-7492 (8 a.m.-8 p.m. E.S.T.)

FAX FAXBACK Automated Fax Retrieval System: 1-800-573-0153 or 1-516-921-6704 / ext. 1667

World Wide Web Address: <http://www.honeywell.com/security>

Regulatory Agency Statements

UL NOTICE: This is a "Grade A" residential system.

FCC STATEMENT

THIS DEVICE COMPLIES WITH PART 15 OF FCC RULES. OPERATION IS SUBJECT TO THE FOLLOWING TWO CONDITIONS: (1) THIS DEVICE MAY NOT CAUSE HARMFUL INTERFERENCE, AND (2) THIS DEVICE MUST ACCEPT ANY INTERFERENCE RECEIVED, INCLUDING INTERFERENCE THAT MAY CAUSE UNDESIRE OPERATION.

Federal Communications Commission (FCC) Part 15 Statement

This equipment has been tested to FCC requirements and has been found acceptable for use. The FCC requires the following statement for your information:

This equipment generates and uses radio frequency energy and if not installed and used properly, that is, in strict accordance with the manufacturer's instructions, may cause interference to radio and television reception. It has been type tested and found to comply with the limits for a Class B computing device in accordance with the specifications in Part 15 of FCC Rules, which are designed to provide reasonable protection against such interference in a residential installation. However, there is no guarantee that interference will not occur in a particular installation. If this equipment does cause interference to radio or television reception, which can be determined by turning the equipment off and on, the user is encouraged to try to correct the interference by one or more of the following measures:

- If using an indoor antenna, have a quality outdoor antenna installed.
- Reorient the receiving antenna until interference is reduced or eliminated.
- Move the radio or television receiver away from the receiver/control.
- Move the antenna leads away from any wire runs to the receiver/control.
- Plug the receiver/control into a different outlet so that it and the radio or television receiver are on different branch circuits.

If necessary, the user should consult the dealer or an experienced radio/television technician for additional suggestions. The user or installer may find the following booklet prepared by the Federal Communications Commission helpful: "Interference Handbook." This booklet is available from the U.S. Government Printing Office, Washington, DC 20402.

The user shall not make any changes or modifications to the equipment unless authorized by the Installation Instructions or User's Manual. Unauthorized changes or modifications could void the user's authority to operate the equipment.

Federal Communications Commission (FCC) Part 68

This equipment complies with Part 68 of the FCC rules. On the front cover of this equipment is a label that contains the FCC registration number and Ringer Equivalence Number (REN). You must provide this information to the telephone company when requested.

This equipment uses the following USOC jack: RJ31X

This equipment may not be used on telephone-company-provided coin service. Connection to party lines is subject to state tariffs.

This equipment is hearing-aid compatible.

Ringer Equivalence Number Notice:

The **Ringer Equivalence Number** (REN) assigned to each terminal device provides an indication of the maximum number of terminals allowed to be connected to a telephone interface. The termination on an interface may consist of any combination of devices subject only to the requirement that the sum of the Ringer Equivalence Numbers of all the devices does not exceed 5.

Specifications

LYNXR-ENSIA Security Controls

1. Physical: 10-3/8" W x 7-1/8" H x 1-3/4" D

2. Electrical:

VOLTAGE INPUT: 9VAC from plug-in 15VA transformer.

RECHARGEABLE BACKUP BATTERY: Six 1.2-volt/cell nickel-metal hydride rated at 1100 mA.

ALARM SOUNDER: Piezo = 6-14VDC, 30mA max/ Bell = 6-14VDC, 120mA max (e.g., ADEMCO's WAVE2EX).

NEGATIVE TRIGGER: Rated 12mA@12-volt nominal (negative trigger signal).

3. Communication:

FORMATS SUPPORTED:

ADEMCO Express, 10 characters/sec, DTMF (TouchTone) Data Tones, 1400/2300Hz ACK, 1400Hz KISSOFF.

ADEMCO Contact ID® Reporting, 10 characters/sec., DTMF (TouchTone) Data Tones, 1400/2300Hz ACK, 1400Hz KISSOFF.

ADEMCO Low Speed, 10 pulses/sec, 1900Hz Data Tone, 1400Hz ACK/KISSOFF.

Radionics/SESCO, 20 pulses/sec, 1800Hz Data Tone, 2300Hz ACK/KISSOFF. Can report 0-9, B-F.

Line Seize: Double Pole

Ringer Equivalence: 0.6B

FCC Registration No.: 5GBUSA-25623-AL-E

4. Maximum Zone 1 Resistance: 300 ohms, excluding 2k ohm EOLR

LYNXR-ENSIA Installation and Setup Guide

LYNXR-ENSIA PROGRAMMING DEFAULT TABLES (boldface indicates defaults that differ between tables)

Function	Table 1	Table 2	Table 3	Table 4
*20 Installer code	4112	4112	4112	4112
*21 Quick arm enable	1	1	1	1
*22 Keypad backlight timeout	0	0	0	0
*23 Forced bypass	0	0	0	0
*24 RF house ID code	0,0	0,0	0,0	0,0
*25 Powerline carrier device house code	0	0	0	0
*26 Chime-by-zone	0	0	0	0
*27 Real-time clock display	1	1	1	1
*29 Daylight saving time start/end month	4,10	4,10	4,10	4,10
*30 Daylight saving time start/end weekend	1,5	1,5	1,5	1,5
*31 Single alarm sounding per zone	0	0	0	0
*32 Fire sounder timeout	0	0	0	0
*33 Alarm bell timeout	1	1	1	1
*34 Exit delay	6,0	6,0	6,0	6,0
*35 Entry delay 1 (zone type 01)	3,0	3,0	3,0	3,0
*36 Entry delay 2 (zone type 02)	3,0	3,0	3,0	3,0
*38 Confirmation of arming ding	0	0	0	0
*39 Cross zone timer	0	0	0	0
*40 PABX access code/Call Waiting Disable	---	---	---	---
*41 Primary phone number	---	---	---	---
*42 Secondary phone number	---	---	---	---
*43 Primary subscriber account number	15,15,15,15	15,15,15,15	15,15,15,15	15,15,15,15
*44 Secondary subscriber account number	15,15,15,15	15,15,15,15	15,15,15,15	15,15,15,15
*46 "Follow Me Reminder" Phone Number	---	---	---	---
*47 Phone system select	5	5	5	5
*48 Report format	7,7	7,7	7,7	7,7
*49 Split/dual reporting	0	0	0	9
*50 Burglary abort window	2	2	2	2
*51 Periodic test report	0	3	0	0
*52 First test report offset	2	2	2	2
*53 Sescoa/radionics select	0	0	0	0
*54 Lack of usage notification	0	0	0	0
*56 Enhanced Zone programming	See *56 table	See *56 table	See *56 table	See *56 table
*57 False Alarm Options	7	7	7	7
*58 RF jam detection	0	0	0	0
*59 Exit error report code	1	1	1	1
*60 Trouble report code	1,0	1,0	1,0	1,0
*61 Bypass report code	0,0	0,0	0,0	0,0
*62 AC loss report code	0,0	0,0	0,0	0,0
*63 Low battery Report code	1,0	1,0	1,0	1,0
*64 Test report code	1,0	1,0	1,0	1,0
*65 Open report code	0	0	0	0
*66 Arm away/stay report code	0,0	0,0	0,0	0,0
*67 RF transmitter low battery report code	1,0	1,0	1,0	1,0
*68 Cancel report code	1,0	1,0	1,0	1,0
*69 Recent close report code	1	1	1	1
*70 Alarm restore codes	1	1	1	1
*71 Trouble restore report code	1,0	1,0	1,0	1,0
*72 Bypass restore report code	0,0	0,0	0,0	0,0
*73 AC restore report code	0,0	0,0	0,0	0,0
*74 Low battery restore report code	1,0	1,0	1,0	1,0
*75 RF transmitter low battery restore report code	1,0	1,0	1,0	1,0
*76 Test restore report code	1,0	1,0	1,0	1,0
*80 Powerline Carrier Devices	See *80 table	See *80 table	---	See *80 table
*81 Zone lists for devices	See *81 table	See *81 table	See *81 table	See *81 table
*84 Assign zone voice descriptors	Refer to *84 Programming			
*87 Auxiliary Function/ 1-button paging	0	1	0	1
*88 Pager characters	---	---	---	---
*89 Event log 80% full report code	0,0	0,0	0,0	0,0
*90 Event logging	3	15	3	3
*91 Alarm audio verification/remote phone control	2	2	2	2
*92 Swinger shutdown	1	1	1	1
*93 Flexible call back	0	0	0	0
*94 Download phone number	---	---	---	---
*95 Ring detect count for downloading/remote phone control	15	15	15	15
Default Master Code	1,2,3,4	1,2,3,4	1,2,3,4	1,2,3,4
Default Report Code for Zone 92 (Duress)	0	0	0	0
Default Duress Code	---	---	---	---

By activating *96, Field 43, and 44 will be changed to 15, 15, 15, 15.

***56 ZONE ASSIGNMENT/ALARM REPORT CODES FOR TABLE 1**

Zone No.	Zone Type	Alarm Code	Input Type	Loop Number	Zone Descriptor
1	0	0,0	---	---	
2	1	1,0	3 (RF)	2	47, 04 (FRONT DOOR)
3	1	1,0	3 (RF)	2	33, 04 (BACK DOOR)
4	3	1,0	3 (RF)	2	80 (WINDOW)
5	10	1,0	3 (RF)	1	56 (MOTION DETECTOR)
26	21	1,0	5 (BR)	3	
27	22	1,0	5 (BR)	2	
28	20	1,0	5 (BR)	4	
29	23	0,0	5 (BR)	1	
30	21	1,0	5 (BR)	3	
31	22	1,0	5 (BR)	2	
32	20	1,0	5 (BR)	4	
33	23	0,0	5 (BR)	1	
92	---	0,0	---	---	
99	6	1,0	---	---	

NOTE: Zone 1 is a hardwire zone; Zone 2 to 41 are RF zones; Zone 92 is Duress; Zone 99 is keypad panic

***56 ZONE ASSIGNMENT/ALARM REPORT CODES FOR TABLE 2**

Zone No.	Zone Type	Alarm Code	Input Type	Loop Number	Zone Descriptor
1	0	0,0	---	---	
2	1	1,0	3 (RF)	2	47, 04 (FRONT DOOR)
3	1	1,0	3 (RF)	2	33, 04 (BACK DOOR)
4	1	1,0	3 (RF)	2	48, 04 (GARAGE DOOR))
5	04	1,0	3 (RF)	1	56 (MOTION DETECTOR)
6	9	1,0	3 (RF)	1	22, 02 (SMOKE DETECTOR)
26	21	1,0	5 (BR)	3	
27	22	1,0	5 (BR)	2	
28	20	1,0	5 (BR)	4	
29	23	0,0	5 (BR)	1	
30	21	1,0	5 (BR)	3	
31	22	1,0	5 (BR)	2	
32	20	1,0	5 (BR)	4	
33	23	0,0	5 (BR)	1	
92	---	0,0	---	---	
95	08	1,0	---	---	
96	09	1,0	---	---	
99	07	1,0	---	---	

NOTE: Zone 1 is a hardwire zone; Zone 2 to 41 are RF zones; Zone 92 is Duress; Zone 99 is keypad panic

***56 ZONE ASSIGNMENT/ALARM REPORT CODES FOR TABLES 3 & 4**

Zone No.	Zone Type	Alarm Code	Input Type	Loop Number	Zone Descriptor
1	0	0,0	---	---	
2	1	1,0	3 (RF)	2	47, 04 (FRONT DOOR)
3	1	1,0	3 (RF)	2	33, 04 (BACK DOOR)
4	3	1,0	3 (RF)	2	80 (WINDOW)
5	3	1,0	3 (RF)	2	80 (WINDOW)
6	3	1,0	3 (RF)	2	80 (WINDOW)
7	3	1,0	3 (RF)	2	80 (WINDOW)
8	10	1,0	3 (RF)	1	56 (MOTION DETECTOR)
9	9	1,0	3 (RF)	1	22, 02 (SMOKE DETECTOR)
26	21	1,0	5 (BR)	3	
27	22	1,0	5 (BR)	2	
28	23	0,0	5 (BR)	4	
29	23	0,0	5 (BR)	1	
30	21	1,0	5 (BR)	3	
31	22	1,0	5 (BR)	2	
32	23	0,0	5 (BR)	4	
33	23	0,0	5 (BR)	1	
92	---	0,0	---	---	
99	6	1,0	---	---	

NOTE: Zone 1 is a hardwire zone; Zone 2 to 41 are RF zones; Zone 92 is Duress; Zone 99 is keypad panic

LYNXR-ENSIA Installation and Setup Guide

***80 DEFAULT TABLE: APPLIES TO DEFAULT TABLE 1 and 2 (devices 1-7 have no default values)**

Device Number	Action	Start			Stop	
		Event	Zone List	Zone Type System Operation	Restore of Zone List	Zone type System operation
8**	2			33		36

***80 DEFAULT TABLE: APPLIES TO DEFAULT TABLE 4 (devices 2-7 have no default values)**

Device Number	Action	Start			Stop	
		Event	Zone List	Zone Type System Operation	Restore of Zone List	Zone type System operation
1	2	2	1		2	
8**	2			33		36

**** NOTE:** If using an X-10 Powerhouse Security SH10A siren as device 8, you must change the device action default to "3" if using default table 4.

***81 ZONE LIST FOR OUTPUT DEVICES DEFAULT TABLE: Applies To Default Table 1 - 4.**

Zone List 1	28, 32
Zone List 2	29, 33
Zone List 3	2, 3

-Index -

- *56 Enhanced Zone Programming Mode ... 11, 23, 27, 28
- *80 Device Programming..... 27, 32, 33, 34
- *81 Zone List Menu Mode 27, 35
- *83 Enhanced Sequential Mode 27, 28, 30, 31, 36, 37, 37
- *84 Assign Zone Voice Descriptors 27, 31, 39, 40
- *85 Record Custom Voice Descriptors 27, 41
- *96 Initialize Download ID and Subscriber Acct. No. for
 Downloading 27
- *97 Set All Program Fields to 1 of 4 Sets of Default
 Values..... 27
- *98 Exits Programming Mode..... 27
- *99 Exits Programming Mode..... 27
- 1.2-Volt Nickel-Metal Hydride Batteries..... 10
- 24-Hour Audible Alarm 16
- 24-Hour Auxiliary Alarm 16
- 24-Hour Silent Alarm 15, 48
- 5800 Series Transmitters 11
- 5800RL 11, 13
- 5801 11
- 5802MN..... 11, 12
- 5802MN2..... 12
- 5804 11, 12, 36
- 5804BD..... 11, 12, 17
- 5804BDV 11, 12, 17
- 5804E..... 11, 12
- 5816 11, 36
- 5817 11
- 5827 11, 13, 17
- 90 53

A

- AC Loss Report Code 24, 62
- AC Power..... 9
- AC Power and Rechargeable Backup Battery 10
- AC Power Loss 9
- AC Restore Report Code 62
- AC Transformer 6
- ADEMCO 1332/1332X10 9
- ADEMCO Express 21, 61
- ADEMCO Low Speed..... 21, 61
- Alarm Audio Verification (AAV)/Remote Phone Control
 25
- Alarm Audio Verification (Two-Way Voice Feature).... 51
- Alarm Bell Timeout 17, 61
- Alarm Output..... 4
- Alarm Restore Codes 62
- Alarm Restore Report Code..... 24
- Alarm Sounder..... 61
- Arm Away/Stay Report Code..... 24, 62
- Arm-Away..... 16
- Armed System Test..... 54
- Arm-Stay 16
- Assign (or Change) a Secondary Security Code..... 48
- Assign Custom Voice Descriptors 41
- Assign Zone Voice Descriptors 39, 62
- AUX Function 25, 49, 62
- AUX Key..... 25
- AWAY Mode..... 49

B

- Babysitter Code 48
- Back Plate 5
- Backlighting..... 17
- Backup Battery 9
- Backup Reporting 19
- Battery Life..... 12
- Battery, Low 53
- Bell 61
- BR..... 11, 29
- Burglary Abort Window 22, 61
- Burglary Zones 17
- Busy-Standby..... 53
- Button Transmitters..... 11, 12
- Button Type 29
- Button Zones 29
- Bypass Report Code..... 24, 62
- Bypass Restore Report Code 24, 62

C

- CA Message Display 52
- Callback Number 26
- Cancel Report Code 62
- Canceled Alarm 23
- CC..... 53
- Change the Master Code 48
- Chime By Zone..... 17, 61
- Chime Mode 17, 49
- Comm. Failure 53
- Communication..... 4
- Communication Overview 55
- Compass Downloader 46
- Confirmation of Arming Ding 18, 61
- Connecting AC Power And Backup Battery 9
- Contact ID..... 55
- Contact ID Event Codes 56
- Contact ID Format..... 23, 48
- Contact ID Reporting 56, 61
- Contacting Technical Support..... 59
- Cross Zone Timer 18
- Custom Descriptor Number 41
- Custom Voice Descriptors 27, 41

D	
Data Encryption.....	46
Data Field.....	14
Daylight Savings Time Start/End	17, 61
Default Master Code.....	61
Default Tables.....	61
Delete a Secondary Security Code.....	48
Delete Entire Zone List.....	35
Delete Zone Parameters Confirmation	30, 37
Delete Zones	35
Descriptor 1	31, 39
Descriptor 2	31, 39
Descriptor 3	31, 39
Desktop Mounting.....	5
Device Action.....	34
Device Number.....	34
Di Display.....	53
DIP Switches.....	11
Disable Local Sounder	7
Disarm	16, 49
Displays	53
Download Call Back Phone Number	26
Download Phone Number.....	62
Download, Initial.....	46
Downloader.....	25, 46, 47
Duress Code.....	48, 63

E	
EA.....	52
Earth Ground.....	6
Encrypted (High-Security) Devices	12, 13, 29
Enroll Mode.....	30, 37
Enter/Change The Master Code.....	48
Entry Delay 1	18, 60
Entry Delay 2	18, 60
Entry/Exit Burglary #1.....	15
Entry/Exit Burglary #2.....	15
Error Code 374	23
Event Log 80% Full Report Code	25, 62
Event Logging	25, 62
Event Logging, Options	25
Exit Alarm.....	23
Exit Delay.....	18, 60
Exit Delay Restart	49
Exit Door	18
Exit Error Alarm Displays.....	52
Exit Error Report Code.....	23, 62
Exiting Program Mode.....	14
Expert Programming	14
Express	55
External Sounder.....	17

F	
Factory Defaults.....	14
Fault	53
FC	53, 55
FCC Statement	60
Features	4
Fire Sounder Timeout.....	17, 60
First Test Report Offset.....	22, 62
Flexible Callback.....	26, 46, 62
Follow Me Reminder” Phone Number.....	19
“Follow Me” Alarm Announcement	52
“Follow Me” Reminder Feature	52
Forced Bypass	17, 50, 60

G	
General Information	11
General Programming Information	14
Go/No Go Test Mode	12

H	
Handshake Frequency.....	55
Hardwire Zone	6, 29, 63
Hayes.....	46
House ID.....	11, 13, 17, 33
House Identification.....	11

I	
Input Type.....	11, 29, 63
Installer Code.....	17, 48, 60
Interactive Mode	14
Interior W/Delay	16
Interior, Follower	15

K	
Keypad Backlight Timeout.....	17, 60
Keypad Functions	49, 50
Keys	11
Kissoff Frequency	55

L	
Lack of Usage Notification	22
Local Sounder Disable Jumper	6
Loop and Serial Number.....	29
Loop Number.....	29, 63
Low Bat	53
Low Battery Report Code	24, 62
Low Battery Restore Report Code.....	24, 62
Low Speed	55
LYNX-DM.....	5
LYNXRCHKIT-HC	10
LYNXRCHKIT-SC	10

M	
Macro Function	25
Master Code	48
Master Security Code	17
Memory of Alarm	49
Message Center.....	49
Modem Comm	53
Mounting Base.....	5
Mute System Announcements.....	49

N	R
No Alarm Response 16	Radionics 21
No Delay 49	Radionics/SESCOA 60
	Range 11
O	Real Time Clock Display 17, 60
Open Report Code 62	Recent Closing Report 25
Open Report Code 24	Rechargeable Backup Battery 9
Operator Commands 51	Record a Message 49
Optima 24 Plus FAX96 Modem 46	Remote Phone Access 26
Other Features 4	Remote Phone Control 50
Other Functions 49	Remote Programming 46
	Remote Programming/Control 46, 47
P	Replacing the Rechargeable Battery 10
PABX Access Code 19, 60	Report Code 23, 29
Pager 22	Report Code Formats 55
Pager Characters 25, 62	Report Format 21, 60
Pager Function 50	Restart Exit Delay 49
Pager Message 25	RF 29
Pager Report Format 22	RF (Supervised RF) 11
Paging Feature 25	RF House ID Code 17, 60
Panic Keys 48	RF Transmitter Low Battery Report Code 24, 62
PC 53	RF Transmitter Low Battery Restore 62
Perimeter Burglary 15	RF Transmitter Low Battery Restore Code 24
Periodic Test Report 22, 62	RF jam 23
PH 53	Ring Detect Count for Downloading 26, 62
Phone Lines 6	
Phone System Select 21, 60	
Piezo 60	
Play Back a Message 49	
Plug-In Transformer 9	
Power Failure 53	
Power Up In Previous State 60	
Powerline Carrier Devices 6, 17, 32, 33, 52, 62	
Powerline Carrier Device House Code 60	
Powerline Carrier Device Programming 34	
Primary Phone Number 19, 60	
Primary Subscriber Account Number 19, 60	
Program Mode, Entering 14	
Programming Default Tables 60	
Programming Mode 17	
Q	
Quick Arm 49	
Quick Arm Enable 17, 60	

S	
Scheduling	47, 49
Secondary Phone Number	19, 60
Secondary Subscriber Account Number	19, 60
Secondary User Codes	48
Security Code Handshake	46
Security Codes	17, 48
Security Functions	49
Serial Number	27, 28, 30, 31, 36, 37
Sescoa/Rad	55
Sescoa/Radionics Select	22, 23, 62
Setting DIP Switches	13
SH10A	34
Signal Strength	12
Silent Burglary	16
Single Alarm Sounding Per Zone	17, 60
Siren/Horn	34
Site-Initiated Remote Programming	46
SMARTMODEM 1200	46
Smoke Detectors	58
Sniffer Mode	12, 54, 57
Sounders	6
Speaker Phone Operation	50
Special Features	4
Specifications	60
Split/Dual Reporting	22, 60
Start By Event	32
Start By Zone Type	32
Start Event Type	34
Start Zone List	34
Start Zone Type	34
Station-Initiated Remote Programming	46
Stay Mode	49
Stop Recording	49
Stop Zone List	34
Stop Zone Type	34
Supervised Fire	16
Supervised RF	11, 29
Swinger Shutdown	26
System Battery	57
System Communication	55, 56
System Features	4
System Operation	32, 33, 48, 49, 50, 51, 52, 53, 64
System Power	4
System Words	40

T	
Technical Support	59
Telco Handoff	46
Temporal Pulse	18
Test Mode	49, 54, 57, 58
Test Report Code	24, 62
Test Restore Report Code	62
Testing the System	54
Time and Date	49
Transmitter Loop Numbers	13
Transmitter Supervision	11
Transmitters	11
Trouble By Day/	15
Trouble Conditions	53
Trouble Report Code	24, 62
Trouble Restore Report Code	24, 62
Troubleshooting Guide	57
Two-Way Voice	6

U	
Unsupervised Button RF	11
Unsupervised RF	11
UR (Unsupervised RF)	11, 29
User Codes	4, 49

V	
Voice Descriptor	29, 31, 39
Voice Prompt Programming Mode	14
Voice Vocabulary Index	40
Voltage Input	60
Volume Control	49

W	
Wall Mounting	5
WAVE2EX	60
Wireless Buttons	11
Wireless Transmitter	24
Wiring Connections	6
World Wide Web Address	59

X	
X-10	32, 47, 52

Z	
Zone 1 Resistance	60
Zone Bypass	49
Zone Descriptor	63
Zone Entry to List	35
Zone List	27, 62, 64
Zone List Number	35
Zone List Programming	35
Zone Number	29, 36, 39
Zone Programming	62
Zone Response Type	15, 16
Zone Type	29, 34
Zones and Devices	4

UL NOTICES

1. For UL Residential Burglar Alarm installations with line security, total exit delay time must not exceed 60 seconds. For UL Burglar Alarm installations without line security (Grade A), total exit delay time must not exceed 120 seconds.
2. Periodic testing (see scheduling mode) must be at least every 24 hours.
3. Alarm Sounder plus Auxiliary Power currents must not exceed 600mA total for UL installations (Aux power 500mA max.).
4. Remote downloading without an alarm company technician on-site (unattended downloading) is not permissible for UL installations.
5. Auto-disarming is not a UL Listed feature.
6. As SIA limits for delay of alarm reporting and sounding can exceed UL limits for commercial and residential applications, the following UL requirements per UL681 are provided:
The maximum time that a control unit shall be programmed to delay the transmission of a signal to a remote monitoring location, or to delay the energizing of a local alarm sounding device to permit the alarm system user to enter and disarm the system, or to arm the system and exit shall not exceed:
 - a) 60 seconds for a system with standard line security or encrypted line security,
 - b) 120 seconds for a system without standard line security or encrypted line security, or
 - c) 120 seconds for a system that does not transmit an alarm signal to a remote monitoring location.

SIA Quick Reference Guide

1. *31 Single Alarm Sounding per Zone: If "0" selected, "alarm sounding per zone" will be the same as the "number of reports in armed period" set in field *92 (1 if one report, 2 if 2 reports).
2. *34 Exit Delay: Minimum exit delay is 45 seconds.
3. *35/*36 Entry Delay 1 and 2: Minimum entry delay is 30 seconds. When added together the entry delay plus the dialer delay should not exceed 1 minute.
4. *39 Swinger Shutdown: Default is "0" no cross zoning
5. *40 PABX Access Code/Call Waiting Disable: If call waiting is used, call waiting cancel option in field *47 must be set.
6. *47 Phone system Select: If call waiting is used, Call Waiting Disable must be enabled.
7. *50 Burglary Abort Window: Delay must be a minimum of 30 seconds.
8. *57 False Alarm Options: Default is "7" cancel alarm display, auto stay arming and exit time restart/reset enabled.
9. *59 Exit Error Alarm Report Code: Always enabled.
10. *68 Cancel Report Code: Default is "code enabled."
11. *69 Recent Closing Report Code: Always enabled.
12. *92 Swinger Shutdown: Default is "1" shutdown after one trip.

WARNING
THE LIMITATIONS OF THIS ALARM SYSTEM

While this System is an advanced design security system, it does not offer guaranteed protection against burglary, fire or other emergency. Any alarm system, whether commercial or residential, is subject to compromise or failure to warn for a variety of reasons. For example:

- Intruders may gain access through unprotected openings or have the technical sophistication to bypass an alarm sensor or disconnect an alarm warning device.
- Intrusion detectors (e.g., passive infrared detectors), smoke detectors, and many other sensing devices will not work without power. Battery-operated devices will not work without batteries, with dead batteries, or if the batteries are not put in properly. Devices powered solely by AC will not work if their AC power supply is cut off for any reason, however briefly.
- Signals sent by wireless transmitters may be blocked or reflected by metal before they reach the alarm receiver. Even if the signal path has been recently checked during a weekly test, blockage can occur if a metal object is moved into the path.
- A user may not be able to reach a panic or emergency button quickly enough.
- While smoke detectors have played a key role in reducing residential fire deaths in the United States, they may not activate or provide early warning for a variety of reasons in as many as 35% of all fires, according to data published by the Federal Emergency Management Agency. Some of the reasons smoke detectors used in conjunction with this System may not work are as follows. Smoke detectors may have been improperly installed and positioned. Smoke detectors may not sense fires that start where smoke cannot reach the detectors, such as in chimneys, in walls, or roofs, or on the other side of closed doors. Smoke detectors also may not sense a fire on another level of a residence or building. A second floor detector, for example, may not sense a first floor or basement fire. Finally, smoke detectors have sensing limitations. No smoke detector can sense every kind of fire every time. In general, detectors may not always warn about fires caused by carelessness and safety hazards like smoking in bed, violent explosions, escaping gas, improper storage of flammable materials, overloaded electrical circuits, children playing with matches, or arson. Depending on the nature of the fire and/or location of the smoke detectors, the detector, even if it operates as anticipated, may not provide sufficient warning to allow all occupants to escape in time to prevent injury or death.
- Passive Infrared Motion Detectors can only detect intrusion within the designed ranges as diagrammed in their installation manual. Passive Infrared Detectors do not provide volumetric area protection. They do create multiple beams of protection, and intrusion can only be detected in unobstructed areas covered by those beams. They cannot detect motion or intrusion that takes place behind walls, ceilings, floors, closed doors, glass partitions, glass doors, or windows. Mechanical tampering, masking, painting or spraying of any material on the mirrors, windows or any part of the optical system can reduce their detection ability. Passive Infrared Detectors sense changes in temperature; however, as the ambient temperature of the protected area approaches the temperature range of 90° to 105°F (32° to 40°C), the detection performance can decrease.
- Alarm warning devices such as sirens, bells or horns may not alert people or wake up sleepers if they are located on the other side of closed or partly open doors. If warning devices are located on a different level of the residence from the bedrooms, then they are less likely to waken or alert people inside the bedrooms. Even persons who are awake may not hear the warning if the alarm is muffled by noise from a stereo, radio, air conditioner or other appliance, or by passing traffic. Finally, alarm warning devices, however loud, may not warn hearing-impaired people.
- Telephone lines needed to transmit alarm signals from a premises to a central monitoring station may be out of service or temporarily out of service. Telephone lines are also subject to compromise by sophisticated intruders.
- Even if the system responds to the emergency as intended, however, occupants may have insufficient time to protect themselves from the emergency situation. In the case of a monitored alarm system, authorities may not respond appropriately.
- This equipment, like other electrical devices, is subject to component failure. Even though this equipment is designed to last as long as 10 years, the electronic components could fail at any time.

The most common cause of an alarm system not functioning when an intrusion or fire occurs is inadequate maintenance. This alarm system should be tested weekly to make sure all sensors and transmitters are working properly. The security keypad (and remote keypad) should be tested as well.

Wireless transmitters (used in some systems) are designed to provide long battery life under normal operating conditions. Longevity of batteries may be as much as 4 to 7 years, depending on the environment, usage, and the specific wireless device being used. External factors such as humidity, high or low temperatures, as well as large swings in temperature, may all reduce the actual battery life in a given installation. This wireless system, however, can identify a true low battery situation, thus allowing time to arrange a change of battery to maintain protection for that given point within the system.

Installing an alarm system may make the owner eligible for a lower insurance rate, but an alarm system is not a substitute for insurance. Homeowners, property owners and renters should continue to act prudently in protecting themselves and continue to insure their lives and property.

We continue to develop new and improved protection devices. Users of alarm systems owe it to themselves and their loved ones to learn about these developments.

THIS EQUIPMENT SHOULD BE INSTALLED IN ACCORDANCE WITH THE NATIONAL FIRE PROTECTION ASSOCIATION'S STANDARD 72, CHAPTER 2 (NATIONAL FIRE PROTECTION ASSOC. BATTERYMARCH PARK, QUINCY, MA 02269), PRINTED INFORMATION, DESCRIBING PROPER INSTALLATION, EVACUATION PLANNING AND REPAIR SERVICE IS TO BE PROVIDED WITH THIS EQUIPMENT.

THIS DEVICE COMPLIES WITH PART 15 OF FCC RULES. OPERATION IS SUBJECT TO THE FOLLOWING TWO CONDITIONS:
 (1) THIS DEVICE MAY NOT CAUSE HARMFUL INTERFERENCE, AND
 (2) THIS DEVICE MUST ACCEPT ANY INTERFERENCE RECEIVED, INCLUDING INTERFERENCE THAT MAY CAUSE UNDESIRABLE OPERATION.

NOTE
 USE ONLY
 1332/1332X10
 TRANSFORMERS
 PROVIDED

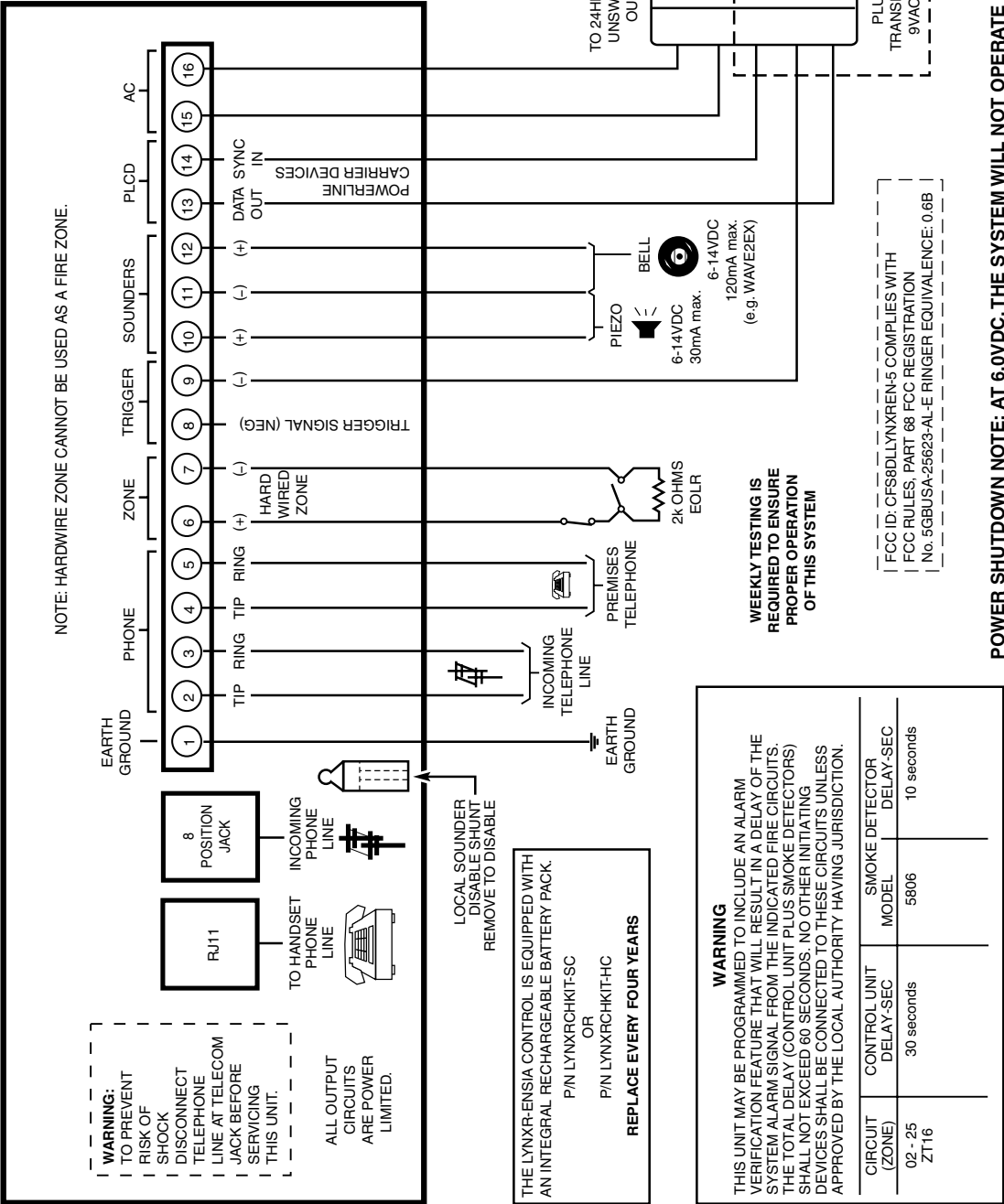

Notes: Connection of the fire alarm signal to a fire alarm headquarters or a central station shall be permitted with the approval of the local authority having jurisdiction. The burglar alarm signal shall not be connected to a police emergency number.
 The System must be checked by a qualified technician once every three years.

LYNXR-ENSIA SERIES SUMMARY OF CONNECTION

LIMITED WARRANTY

Honeywell International Inc. acting through its Security & Custom Electronics business ("Seller"), 165 Eileen Way, Syosset, New York 11791, warrants its products to be in conformance with its own plans and specifications and to be free from defects in materials and workmanship under normal use and service for 24 months from the date stamp control on the product or, for products not having an Ademco date stamp, for 12 months from date of original purchase unless the installation instructions or catalog sets forth a shorter period, in which case the shorter period shall apply. Seller's obligation shall be limited to repairing or replacing, at its option, free of charge for materials or labor, any product, which is proved not in compliance with Seller's specifications or proves defective in materials or workmanship under normal use and service. Seller shall have no obligation under this Limited Warranty or otherwise if the product is altered or improperly repaired or serviced by anyone other than Honeywell factory service. Connection of any device(s) to a communicating bus of a Honeywell security system (e.g., keypad bus, polling loop) other than those manufactured or approved by Honeywell shall void this warranty. For warranty service, return product transportation prepaid, to Honeywell Factory Service, 165 Eileen Way, Syosset, New York 11791.

THERE ARE NO WARRANTIES, EXPRESS OR IMPLIED, OF MERCHANTABILITY, OR FITNESS FOR A PARTICULAR PURPOSE OR OTHERWISE, WHICH EXTEND BEYOND THE DESCRIPTION ON THE FACE HEREOF. IN NO CASE SHALL SELLER BE LIABLE TO ANYONE FOR ANY CONSEQUENTIAL OR INCIDENTAL DAMAGES FOR BREACH OF THIS OR ANY OTHER WARRANTY, EXPRESS OR IMPLIED, OR UPON ANY OTHER BASIS OF LIABILITY WHATSOEVER, EVEN IF THE LOSS OR DAMAGE IS CAUSED BY THE SELLER'S OWN NEGLIGENCE OR FAULT.

Seller does not represent that the products it sells may not be compromised or circumvented; that the products will prevent any personal injury or property loss by burglary, robbery, fire or otherwise; or that the products will in all cases provide adequate warning or protection. Customer understands that a properly installed and maintained alarm may only reduce the risk of a burglary, robbery, fire or other events occurring without providing an alarm, but it is not insurance or a guarantee that such will not occur or that there will be no personal injury or property loss as a result. CONSEQUENTLY, SELLER SHALL HAVE NO LIABILITY FOR ANY PERSONAL INJURY, PROPERTY DAMAGE OR OTHER LOSS BASED ON A CLAIM THE PRODUCT FAILED TO GIVE WARNING. HOWEVER, IF SELLER IS HELD LIABLE, WHETHER DIRECTLY OR INDIRECTLY, FOR ANY LOSS OR DAMAGE ARISING UNDER THIS LIMITED WARRANTY OR OTHERWISE, REGARDLESS OF CAUSE OR ORIGIN, SELLER'S MAXIMUM LIABILITY SHALL NOT IN ANY CASE EXCEED THE PURCHASE PRICE OF THE PRODUCT, WHICH SHALL BE THE COMPLETE AND EXCLUSIVE REMEDY AGAINST SELLER. This warranty replaces any previous warranties and is the only warranty made by Seller on this product. No increase or alteration, written or verbal, of the obligations of this Limited Warranty is authorized

Honeywell

165 Eileen Way, Syosset, New York 11791

Copyright © 2007 Honeywell International Inc.

www.honeywell.com/security



K5963-2V1 1/07 Rev. A